

## Change Record 变更记录

修改说明	Modification description
------	--------------------------

版本	修改日期	修改原因	
1534352-T2-B	2025-07-05	删除水效说明表格	
1534352-T2-C	2025-11-19	RoHS升版	
1534352-T2-D	2026-02-09	更改新国标相关内容	
1534352-T2-E	2026-04-09	更改用水量	

卡丽 KARAT

安装使用说明书 INSTALLATION  
INSTRUCTIONS

欧申纳斯PRO一体化智能坐便器, 305mm坑距/400mm坑距  
OCEANUS PRO INTEGRATED IT, 305mm/400mm RI  
32821T-WK/32822T-WK

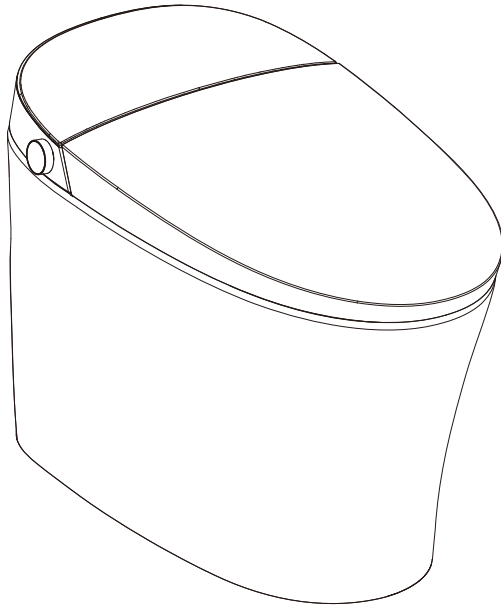

1534352-T2-E

# CONTENTS

## 目录

安装之前Before Installation.....	1
产品简介Introduction.....	2
功能Function.....	2
安全注意事项Safety Precautions.....	3
技术参数Technical Parameters.....	8
尺寸图Dimensions.....	9
安装尺寸图Installation Drawing.....	9
整体图说明Introduction to Overall Diagram.....	10
产品安装Installation.....	10
确认通水、连接电源 Confirmation of water and Power Connection.....	13
脚感应功能Foot sensing function.....	14
启动泡沫盾 Activate foam shield.....	14
主机旋钮功能说明 Functions of Knob.....	15
显示屏LED灯说明 LED display description.....	16
遥控器使用 Usage of Remote Control.....	17
安装遥控器 Remote Control Installation.....	22
日常保养 Daily Maintenance.....	23
过滤阀芯的保养Filter Maintenance.....	24
紧急情况 Emergency Troubleshooting.....	24
故障分析和处理 Fault Analysis and Solution.....	27
联系信息 Contact Information.....	28
环保说明 Environmental Friendliness.....	29
能效水效等级说明 Grade of Energy Efficiency and Water Efficiency.....	29

# 卡丽 K A R A T

## 安装使用说明书 INSTALLATION INSTRUCTIONS

### BEFORE YOU BEGIN 安装之前

- Please read these instructions carefully to familiarize yourself with the required tools, materials, and installation sequences. Follow the sections that pertain to your particular installation. This will help you avoid costly mistakes. In addition to proper installation, read all operating and safety instructions.
- All information in these instructions is based upon the latest product information available at the time of publication.
- These instructions contain important care, cleaning, and warranty information-**Please leave instructions for the consumer.**
- Obey all electrical regulations in force at the time of installation.
- ⚠ **Warning! Risk of personal injury and product damage.** Toilet are very heavy and should not be lifted or installed by just one person.
- 请仔细阅读本指引，以便熟悉所需工具、物料及安装程序。请遵照适用的章节来安装本产品，以免安装失当导致不必要的损失。除了有关正确的安装方法之外，请务必详阅所有操作及安全指引。
- 本指引所载之一切资料，均以印刷时所有之最新产品情况为基础。
- 本指引也包含了有关保养、清洁及担保等重要资料-**请交予用户保存。**
- 遵循当地所有的电器安装规定。
- ⚠ **警告！小心人身伤害和产品受损。**坐便器较重，安装时请勿一人操作。

### SAFETY: WARNINGS

Products are precision engineered and should give continued superior and safe performance, provided:

1. They are installed, commissioned, operated and maintained in accordance with the recommendations given in this Manual.
2. Periodic attention is given, as necessary, to maintain the product in good functional order. Recommended guidelines are given in the MAINTENANCE section.

Carefully inspect the new fixture for any signs of damage.

When installing Products, manufacturers guidelines for power tool safety should be followed.

### 安全：警告

产品经过精确制造，性能卓越，经久耐用。为保证产品品质，您必须：

1. 按照此手册中推荐的方法进行安装、启动、操作及维护。
2. 如有需要，定期检查，令产品保持良好性能状态。日常维护章节中列有推荐方法。

仔细检查新产品是否有损伤。

在安装产品时，必须遵循制造商有关电动工具的安全指令。









### TOOLS AND MATERIALS

Pencil    Measuring Tape    Level    Miter Box    Safety Glasses    Drill    Screwdrivers    Hole Saw

### 工具及材料

铅笔    卷尺    水平尺    钻子箱    安全眼镜    手枪钻    螺丝刀    孔锯

### 产品清单

产品	遥控器	安装纸板	密封圈	说明书
X1	X1	X1	X1	X1
				
角阀	7号电池	加液漏斗	专用泡沫剂	
X1	X1包	X1	X1	
				

This product has the function of warm water cleaning, DRY, seat ring heating, lid open/close, foot sensing function, cleaning intensity adjustment, night light lighting and other functions, and the seat ring temperature, cleaning temperature can be adjusted according to demands.

本产品具有温水清洗、暖风、座圈加热、自动翻盖、脚感功能、清洗强度调节、夜灯照明等功能，座圈温度、清洗温度，可根据需要进行调节。

Functions 功能项目		OCEANUS PRO Function Introduction/欧申纳斯PRO功能介绍	
		32821T-WK/32822T-WK	
Basic functions 基本功能	Rear cleaning/臀洗	●	
	Front cleaning/妇洗	●	
	Seat heating/座圈加热	●	
	Drying/暖风功能	●	
Well-being functions 舒适功能	Wind temperature adjustment/风温可调	●	
	Water temperature adjustment/水温可调	●	
	Seat temperature adjustment/座温可调	●	
	Instant heated 即热式加热	●	
	Move cleaning 移动清洗	●	
	Foam shield 泡沫盾	●	
	Water volume adjustment 清洗流量可调	●	
	Spray cleansing location adjustment 清洗位置可调	●	
	Spray nozzle disassemble 喷嘴可拆卸清洗	●	
	Nozzle cleaning 喷杆自洁	●	
	Remote control 遥控操作	●	
	Lid open/close 自动翻盖	●	
	Side knob control 侧旋钮控制	●	
	Mechanical push button flush/无电按钮冲水	●	
Automatic pre-wetting button/自动预湿润	●		

Functions/功能项目		32821T-WK/32822T-WK
Intelligent technology 智能科技	Seat sensor/着座感应	●
	Foot sensing function/ 脚感功能	●
	Automatic flushing 离座自动冲水	●
	Induction night light 光感夜灯	●
	User ID setting 用户对码设置	●
Safety 安全	Antibacterial Seat 抗菌座圈	●
	Antibacterial Spray nozzle/抗菌喷嘴	●
	Leakage protection switch/漏电开关	●
	Automatic pressure discharging/泄压保护	●
	Heated burning protection/防低温烫伤	●
	Triple protection 三重保护	●
Rough-in distance (mm) 坑距 (mm)		305/400

## NOTICE

## 安全注意事项

In order to avoid injury and property damage to you and others, you must follow the following notes of safety precautions:

Dangers caused by ignoring following warnings or incorrect use fall into two types.



**Warning:** Violation of Warning precautions may lead to serious injury or death.



**Attention:** Violation of Note precautions may lead to injury or property damage.



无视如下警示，因错误的使用方法而产生的危害分为两级。

**警告：**违反警告事项时，可能会造成人的死亡或重伤。



**注意：**违反注意事项时，可能会造成人的伤害或财产的损失。

### WARNING



- The product requires 220V~,50Hz power. Make sure that the power supply is consistent with the rated voltage and reliable grounding exists within the three-pin socket, so as to avoid electric shock or damage to the product.
- Must use 10A electrical outlet. It is recommended to use a water-proof electrical outlet.

### 警告



- 本产品要求电源为220V~, 50Hz, 请确保电源与本机额定电压相符, 保证三芯插座内有可靠的接地, 以免触电或损坏产品。
- 必须使用不小于10A插座, 最好使用防水插座。



This product is a fixed appliance and should be installed and fixed in a specific location by professionals.



本产品属于固定式器具，应由专业人士进行安装、固定于特定位置使用。



The water supply pressure range of this product must be static pressure 0.14MPa (dynamic pressure 0.09 Mpa)-- Static pressure 0.8MPa .



本产品供水水压范围必须为静压0.14MPa（动压0.09Mpa）--静压0.8MPa。



The old aging water supply hose can not be used, otherwise it might cause leakage, fire or electrical shock. Installation of the bidet seat should include specified components and new water supply hose.



安装应使用随器具附带的新软管组件及其它附带或指定的零部件，旧软管组件不能重复利用，否则可能引起漏水、水灾或触电。



Do not use bad electrical outlet or damaged power plugs, and use and protect the power cord property, so as to avoid risks of electric shock or fire due to bad contact or damage.  
If the power cord is damaged, it must be changed by specialist of the manufacturer, its maintenance department or other similar departments, or electric shock or fire may occur.



请勿使用不良的电源插座及破损的电源插头，请正确使用并保护好电源线，以免接触不良，破损等导致触电或引发火灾等危险。

※如果电源软线损坏，为了避免危险，必须由制造商、其维修部或类似部门的专业人员更换，否则容易引起触电、火灾。



This product must be grounded securely. Make sure to provide grounding protection for the AC socket, and use the three-pin socket for the grounding wire. If you are not sure if it is grounded securely, ask a qualified electrician or service person to check and verify the condition. Please make sure the wiring of the power socket used for this product is in compliance with the national standard (null line on the left and live line on the right) and should not be reversed.



本产品必须可靠接地，且需确保交流插座地线对大地的可靠连接，接地线应使用三脚插座。如果不确定是否已可靠接地，请让一位合格的电工或维修人员检查确认。请确保产品使用的电源插座接线符合国家标准（左零右火），不能接反。



A power circuit breaker should be connected in series with the power supply circuit in the same room; Otherwise there may be a risk of personal injury or property damage.



安装本产品时，应在安装产品同一房间的电源进线回路中串联一个能使本产品电源全级断开的分断装置方可安全使用；否则本产品的意外故障可能会导致生命危险或财产损失。



Do not disassemble, repair or modify the product by yourself and should not change internal wiring, components and protective devices., so as to avoid electric shock, fire, electric leakage or other faults.



严禁自行拆卸，修理或改造产品，不应变更内部接线、部件和保护装置。以免造成触电，火灾，漏电或其他故障。



When unplugging the power plug from the socket, hold the plug body and do not apply tension to the power cord.



从插座上拔下电源插头时，须手持插头本体，不应电源线施加拉力。



If the product produces abnormal noise, abnormal odor, abnormal temperature or malfunction, please stop using it immediately, unplug the power plug, close the water supply valve, and contact the service provider in time.



产品出现异常噪声、异常气味、异常高温或故障时，请立即停止使用，关闭开关，断开电源，同时关闭供水阀门，并及时与客服联系。



The drainage pipe connected to this product must be connected to the sewage system.



本产品所连接的排水管必须连接到污水系统。



Do not throw cigarettes and other burning stuff into toilet, otherwise it might cause fire.



点燃的香烟及其它燃烧物不能投入坐便盖内，否则可能会引起火灾。



**WARNING:**  
There is risk of electric shock. This product must be grounded safely, can only connect to exclusive 220V~, 50Hz, 10A circuit which protected by Ground-Fault Circuit-Interrupters (GFCI's) or Earth-Leakage protector.



**警告:**  
产品存在电击的危险。本产品必须可靠接地, 只能连接到专用的220V~, 50Hz, 10A带接地故障断路器或接地漏电保护器的电路中。



Do not use plugs with loose power outlet, do not put the body of the product and plugs in the water or shower them with water, and do not use the product under excessively humid condition, so as to avoid electric shock or fire. When power failure occurs, immediately unplug the power cord and contact maintenance staff.



请勿使用插头配合松动的电源插座, 请勿将本体和插头放在水里或淋水, 请勿在过于潮湿的环境下使用, 以免造成触电或火灾。电源出现故障时请立即拔下电源插头并联系维修人员。



Children, elders or those with disabilities from their body, sensitivity or mental disabilities or lacking of common sense should not use or get close to this product unless under close tutelage. Children are not allowed to use or touch this product. Do not leave children alone in a room with such product. For those children and the elderly who are unable to adjust the temperature, they should ask for help to adjust seat temp, flush temp and wind temp of bidet seat to the proper gears. Exposed skin should not make contact with the heated seat for too long a time to prevent low temperature burning.



当儿童、老年人、残疾人、以及身体、感知、智力能力缺陷或经验和常识缺乏的人使用或靠近此产品时, 近距离的监护是必需的。儿童不应该被允许使用或接触此产品, 不要让儿童独自待在安装有此产品的房间, 儿童不应玩耍器具。对于无法自己进行温度调节操作的儿童和老人, 需要帮助将便盖的圈温、冲水温度及风温调节到合适的档位。请避免长时间让裸露的皮肤接触加热座圈, 以免低温灼伤。



When the product moves from cold or wet environment into normal room temperature, wait for 2 hours until the condensation water is fully volatilized. Doing so can prevent the product from electrical short-circuit.



当产品由寒冷或潮湿的地方搬至室内时, 先放置2小时, 使机内凝水充分挥发, 再开机使用, 以免造成产品短路。



Do not handle the electrical plug with wet hands. Doing so may cause electrical shock.



严禁用湿手触摸电源插头, 否则可能会引起触电。



It is prohibited to use other electric appliances in the same socket.



严禁在同一插座上使用其他电器。



It is forbidden to use the power extension or unstable loose outlet, otherwise it may cause fire or electrical shock.



严禁使用电源延长线或松脱不稳的电源插座, 否则可能会引起火灾或触电。



Do not put hand or other staff over the outlet of air dryer or block the outlet of air dryer. Doing so may cause burn and electrical shock.



请勿用手指或其他物品放入或者堵塞暖风出口, 否则可能会引起烫伤、触电或烧毁。



Do not lay on side or upside the product during the electrical circuit, to avoid fire or burning.



产品通电时, 不得将产品侧放或倒置, 否则可能会引起火灾或烧毁。



Prohibit stepping on the body and cover of the machine and prohibit putting heaters or heavy objects on the unit and cover, power cord of the machine, so as to avoid electric shock or other injuries and damage.



严禁踩踏机器本体和便盖, 严禁把加热器或重物放在机器本体、便盖、电源线上, 以免造成触电或其他伤害和损坏。



Users should not replace fuses in household appliances and power supplies with ordinary conductors or fuses with current capacity exceeding the specified value.



使用者不应以普通导体或超出规定电流容量的熔断体替换家用电器和电源的熔断体。



Users should not change the setting values of low voltage circuit breakers or residual current operated protectors on their own.



使用者不应自行改变低压断路器或剩余电流动作保护器的设定值。



In the same room where the product is installed, it is necessary to install a water stop valve at the accessible position. In case of emergency, the water inlet can be cut off without using any tools. Otherwise, the unexpected failure may lead to the loss of users.



在安装本产品的同一房间中，需要在触手可及的位置安装一个止水阀，用于紧急情况下，无需借助工具即可切断本产品的进水水路；否则本产品的意外故障可能导致用户损失。



For models with foam shield function, do not run the foam shield function without foam agent; otherwise, the service life of the foam shield may be shortened.



若带有泡沫盾功能的机型，请勿在未装有“泡沫剂”的情况下运行泡沫盾功能，否则可能缩短泡沫盾使用寿命。



Please unplug the power cord when it thunders. When out of service for a long time, please cut off water and the circuit and drain water within the product. Do not put the body of the product near heaters or fireplace, which may deform and discolor it. Please prevent the sun from shining directly on the product, which may discolor the product.



在打雷时请将电源线插头拔掉。长期不用时，请将水电路切断，并将产品内部积水排净。请不要把取暖器或壁炉等产品靠近本体，否则会导致本体变形，变色。防止日光直接照射，否则会引起产品变色。



Make sure that the water supply is clean tap water. Do not use contaminated or industrial water.



请确保使用的水源是干净的自来水，不可使用污染的水源或工业用水。



Do not urinate on the nozzle of the cleaner to prevent filth blocking, and do not urinate into the outlet of heater wind to avoid corrosion and electric leakage.



请勿将小便淋于清洗器的喷嘴上以免产生污垢导致堵塞，或将小便射进暖风出口位置，以免产生腐蚀而导致漏电。



Do not use the product in the places close to bathtub or water tank. Do not touch the product that has fallen into liquids, immediately pull out the power plug.



请勿将产品放置在可能掉入或被拉入浴缸或水槽的位置。请勿触及已经掉入水中或浸水的产品，并立刻拔掉电源插头。



Do not reverse the product to use, which damages the product.



请勿将产品翻转使用，否则会损坏产品。



Please don't plunge into toilet bowls with easily blocked items such as newsprint, paper diapers, and sanitary napkins.



请不要向便器内冲入新闻纸、纸尿裤、妇用卫生巾等容易堵塞的物品。





Please do not use gravity to impact the ceramic to prevent damage.





请不要用重力撞击陶瓷，以防止破损漏水。

 Please do not embed cementations materials (cement mortar, etc.) on toilet seats to prevent them from swelling due to swelling.

 请不要在便器底座埋入胶凝材料（水泥砂浆等），以防止因膨胀而撑裂便器。

 Do not strike the product.

 请勿撞击产品。

 Do not use lacquer thinner, petrol, liquid medicine, detergent, insecticide, toilet cleanser and scrubbing brush to clean the product.

 禁止使用香蕉水、汽油、药水及洗涤剂、杀虫剂、厕所清洁剂和硬毛刷清洁本产品。

 This product is equipped with a soft-closing seat cover. Do not push the toilet seat closed, or damage may occur.

 本产品座圈有缓降功能，请勿用力按压，以免损坏缓降器。

 Do not lean against the seat cover when using the product, to avoid damage .

 使用产品时，请勿向后靠在便盖上，以免损坏产品。

 Do not twist and break the water inlet pipe.

 请勿将进水管扭曲破损。

 In winter, when the product is transported over a long distance or kept for a long time, the remaining water in the product may freeze. To prevent damage caused by freezing, please adopt measures to fight against freezing.

 在寒冷的冬季，当产品在经过长途运输或长时间存放时，产品内剩下的积水可能会发生冻结现象。为预防冻结造成损坏，请采取防冻措施。

 Please do not use in environments below 1°C.

 请不要在1°C以下环境中使用。

 When installing, disassembling, repairing, and maintaining the product, you must unplug the power supply and close the water supply valve.

 进行安装、拆卸、维修及保养产品时，必须拔下电源插头，关闭供水阀门。

 **CAUTION:**  
There is risk of hazardous gases. If a new toilet is not installed immediately, a piece of rag can be temporarily covered over the ground outfall.

 **谨慎：**  
存在有害气体的危险。如果新坐便器不能立即安装，可在地面排污口上临时遮盖一块旧布。

 **NOTICE:**  
Receptacles installed in bathroom to be located at least 1 meter from a bathtub or shower if practical.  
Observe all local plumbing and building codes. Carefully inspect the new toilet for damage.

 **注意：**  
安装在浴室内的插座位置距离浴缸或淋浴喷头至少应为一米。  
遵守所有的本地管道安装规程和建筑规范。仔细检查新坐便器有无损坏。

## SPECIFICATIONS

## 技术参数

Rated pressure	220V~,50Hz
Rated power	990W (As for the test condition and standard, please refer to the upper part on page 9.)
Overall unit Waterproof	IPX4
Water pressure range	Static pressure 0.14MPa (dynamic pressure 0.09Mpa)-- Static pressure 0.8MPa
Cleansing flow	The maximum Rear washing is not less than 450mL/min
Electrical wire	length is about 1.2m
Flush volume(L)	4.6L(Full Flush 5.8L/Half Flush 4.0L)
Flushing mode	Siphonic jet
Outlet outside diameter	≤100mm
Drainage method	Down-drain
Washing settings	
Heating power	1500W
Water temperature	6 different level adjustment
Water volume	3 different level adjustment
Cleansing mode	Rear washing/ Move washing, Feminine washing/ Move washing
Spray cleansing location	5 different level adjustment
Water pressure protector	Pressure stabilizer, Automatic pressure discharging
Anti-fouling device	Automatic cleansing nozzle, Anti-syphon device, Anti-backflow device, Filter device
Safety device	Thermal fuse, Water temperature sensor, Ground protection, Thermostat, Over temperature protection, Leakage protection plug
Heater Wind Device	
Warm wind speed	Over 0. 2m <sup>3</sup> /min
Warm wind temperature	6 different level adjustment
Heating power	200W
Safety device	Thermal fuse, Temperature sensor, Thermostat
Seat Heating Device	
Surface temperature	6 different level adjustment
Heating power	50W
Heated burning protection	The seat temperature will automatically lower to level 1 in 10 minutes after using
Safety device	Sensed area, Temperature sensor, Thermal fuse, Bimetal thermostat, Leakage protection plug

额定电压	220V~, 50Hz
额定功率	990W (具体测试条件及参数请参考第九页上半段)
整机防水	IPX4
水压范围	静压0.14MPa (动压0.09Mpa) —静压0.8MPa
清洗流量	臀洗高档不小于450mL/min
电源线	长度约1.2米
平均用水量 (L)	4.6L (大冲5.8L/小冲4.0L)
冲洗方式	喷射虹吸式
排污口外径	≤100mm
排水方式	下排水
清洗装置	
加热功率	1500W
温水温度	6档调节
清洗流量	3档调节
清洗方式	臀洗/移动清洗, 妇洗/移动清洗
喷洗位置	5档调节
水压保护	稳压装置、自动泄压装置
防污装置	喷嘴自动清洗装置、防虹吸装置、防倒流装置、过滤装置
安全装置	温度保险丝、水温传感器、接地保护、温控器、过温保护、漏电保护插头
暖风装置	
暖风风量	大于0.2m <sup>3</sup> /min
暖风风温	6档调节
加热功率	200W
安全装置	温度保险丝、温控器、漏电保护插头
暖座装置	
表面温度	6档调节
加热功率	50W
防低温烫伤	使用10分钟后, 座温自动缓慢降低到低档
安全装置	着座感应器、温度传感器、温度保险丝、温控器、漏电保护插头

Others	
Night light assembly	Intelligent, Often in the off state, Normally on
User ID setting	To avoid disturbance from remote controls by multi-user
Automatic flushing	Toilet will automatically flush as user walks away from bowl
Feet flush sensing function	With Foot sensing flush function
Power off flush	Toilet will washed manually after power failure
Cover opening	Realize the automatic opening and closing of the cover by foot sensor

其他	
夜灯设置	智能、常灭、常亮
用户码设定	防止多台产品多个用户使用，互相干扰
自动冲水功能	可实现便后自动冲刷功能
脚感冲水功能	可实现脚感应冲水功能
断电冲水功能	可实现断电后手动冲刷马桶功能
自动翻盖功能	可实现脚感应翻盖翻圈功能

额定功率：本产品环境温度23℃，进水静压0.18MPa±0.02MPa，进水温度15℃条件下，开始上电开机，依次将水压、座温、水温设置为最高档后，立即开启臀洗并打开移动按摩和脉冲按摩功能，持续稳定工作一个清洗周期的平均功率。

本产品符合GB/T 23131-2019标准中的清洁率要求。本产品最佳清洁率测试方法：将喷杆位置调至最前端，水压档位调至最大档，同时开启移动清洗功能。

抗菌：含无机系抗菌材料的座圈长期抗菌，抑制产品表面的细菌生长，这一加工处理不代表防霉等附带效果。抗菌率大于90%（依据GB21551.2-2010进行试验。测试机构：威凯检测技术有限公司。）

## ROUGHING

## 尺寸图

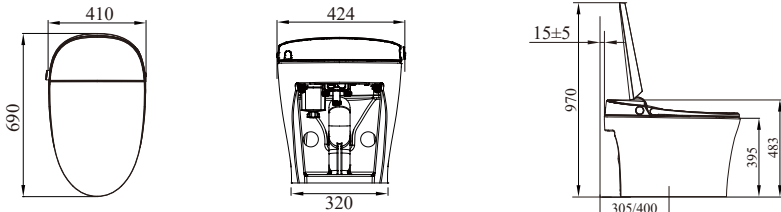

Unit:mm  
单位:mm

\*The size is for reference only, please check the actual size before installation.

\*此尺寸仅供参考，安装前请仔细测量实际产品。

## INSTALLATION DRAWING

## 安装尺寸图

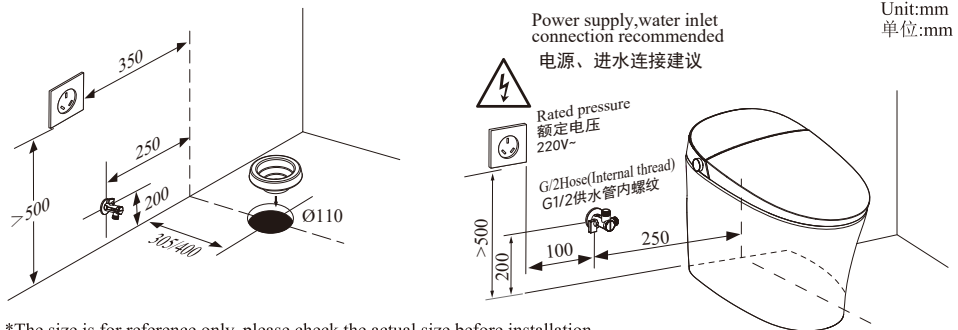

Unit:mm  
单位:mm

\*The size is for reference only, please check the actual size before installation.

\*此尺寸仅供参考，安装前请仔细测量实际产品。

产品左侧面 Left side

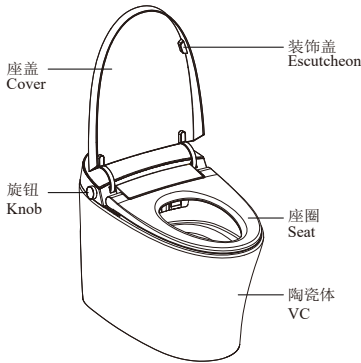

产品右侧面 Right side

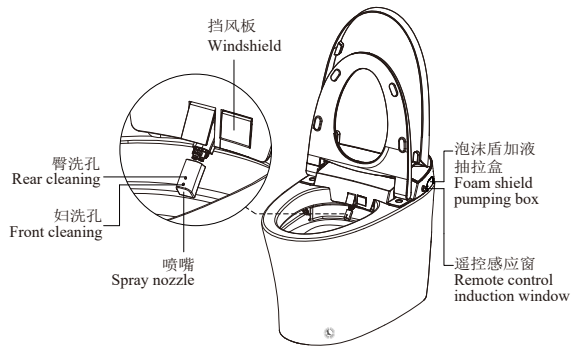

INSTALLATION

产品安装

⚠ Precaution before installing

Minimum static water pressure: 0.14+MPa (15+L/min), failure to meet this pressure will not achieve the best flushing effect.  
Remark: Apply the methods below if you don't have water pressure testing device.

Angle valve type	Water volume 10s
Mating angle valve	More than 2.5L

Reaching appointed water volume represents it meets water pressure requirement.

⚠ 安装前注意事项:

- 最低静态工作压力: 0.14MPa以上 (15L/min 以上), 未能满足此压力将无法达到最佳冲刷效果。  
注: 若无水压测试装置, 可参照下述方式。

角阀类型	水量 (10秒)
配套角阀	2.5L以上

达到表述水量, 则可确保产品最低水压。

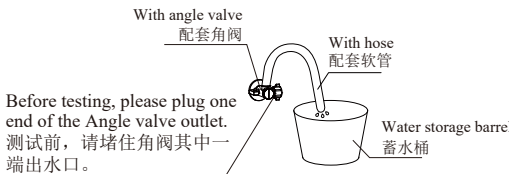

1. Installation of mating angle valve

Draw drain outlet centerline on the floor, Install angle valve at proper position on wall according to dimension of toilet.

Please use the angle valve and hose coming with the product and do not use the old pipe, which may less to risk of water leakage.

If an old Angle valve has been installed on the wall, replace it with a professional to avoid improper removal of the Angle valve.

1. 安装配套角阀

在地面标出排水口的中心线, 按坐便器的尺寸, 在墙面的合适位置安装进水角阀。

温馨提示:

必须使用产品自带的新角阀和新软管组件, 不要使用旧管组件, 否则会引起漏水风险。

若墙面已安装旧角阀, 需由专业人员进行更换, 避免因拆卸不当导致角阀无法安装。

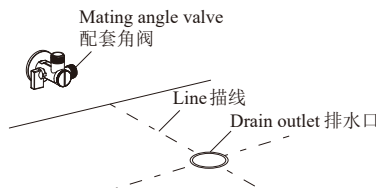

## 2. Cardboard installation

- Align cardboard with the centerline of drain outlet;
- Draw contour line according to cardboard;

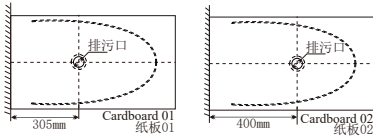

## 3. Installation of angle valve and flexible hose

- Installation of angle valve

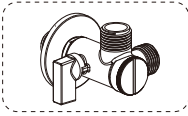

- Connect water inlet and angle valve with new hose

- Attention! Make sure to flush the water supply pipe completely to remove impurities inside the pipe, the water source should be running water or potable water, never use industrial water, wastewater, sewage, or sea water.

## 4. Ceramic toilet installation

- Install sealing flange into drain outlet;
- Install ceramic toilet on corresponding position according to contour line.

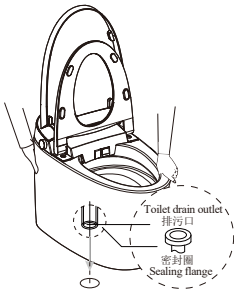

- 5. Apply high quality mildew glass glue around the lower edge of the toilet.

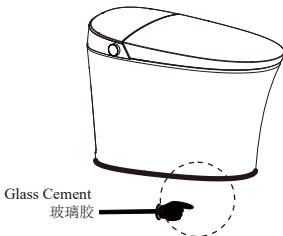

## 2. 安装纸板安装说明

- 将安装纸板对齐排污口中心线;
- 根据安装纸板描绘出相应的轮廓线。

## 3. 安装角阀和软管

- 安装角阀。

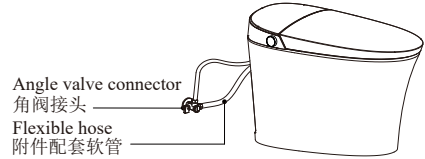

- 用新软管将坐便器的进水口和角阀连接起来。

- 注意! 一定要先彻底冲洗供水管以清除管道中的杂质, 使用水源为自来水或可饮用水, 切勿使用工业用水, 废水, 污水以及海水。

## 4. 安装坐便器

- 将密封圈套入坐便器排污口;
- 根据描绘出的轮廓线将坐便器装入相应位置。

Tips: The toilet is heavy, and it needs to open the seat cover to carry it by two people.

温馨提示: 由于一体机比较重, 需翻开座圈, 由两人配合抬起。

## 5. 涂玻璃胶

- 在便器下边缘周围涂上优质防霉玻璃胶。

Tips: Please clean the drain outlet; Please make sure ceramic toilet outlet sits perfectly on drain outlet.

温馨提示: 请将排污口的垃圾和其他污物清理干净; 安装便器时, 请确保坐便器排水口与地面排污口安装到位。

6. Add foam shield

- Reach under the filling tank with your finger or tool and pull it out (the filling funnel is recommended, as shown below).

6. 添加泡沫盾

- 用手指或者工具伸入加液盒下方将加液盒拉出（建议使用加液漏斗，如下图所示）

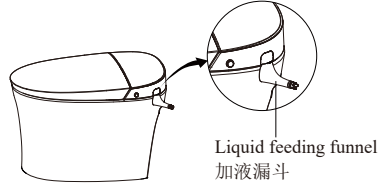

- Remove the seal cover and store.

- 取下密封盖，并保存。

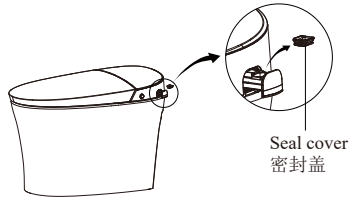

- Put the funnel into the filling port and hold it while the other hand slowly pours the foam into the funnel. (Do not pour foam agent into funnel quickly to avoid foam agent overflow)

- 将漏斗套入加液口，并扶住，另外一只手将泡沫剂缓慢倒入漏斗中。（请勿快速将泡沫剂倒入漏斗中以免泡沫剂溢出）

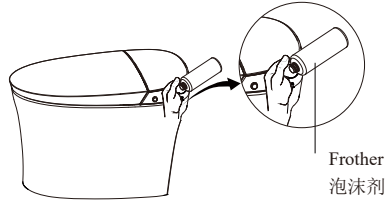

- Close the seal cover and press it firmly, then push the filling pump to the bottom. (If the foam agent overflows during the filling process, use paper towels to dry the liquid and then push it in)

- 盖上密封盖并压紧，然后将加液抽拉盒推到底。（加液过程中若泡沫剂溢出，可用纸巾将液体擦干再推入）

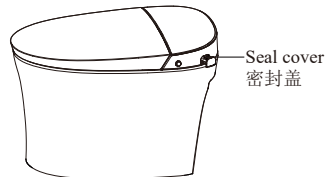

Warm tips:

1. Foam liquid is a consumable product, not covered by warranty, need to be purchased separately.
2. In order to achieve the best effect and prolong the service life of the foam shield, please use our smart toilet special foam agent.

温馨提示:

- 1、泡沫液属于易耗品，不在质保范围，需另行购买。
- 2、为使泡沫盾达到最佳效果以及延长使用寿命，请使用我司智能马桶专用泡沫剂。

## 1. Turn on the angle valve

Check thread connection, make sure no leakage is found, unscrew angle valve anticlockwise to maximum opening.

## 1. 打开角阀

查看螺纹连接处密封性, 确定不漏水, 逆时针旋开角阀, 开口调至最大。

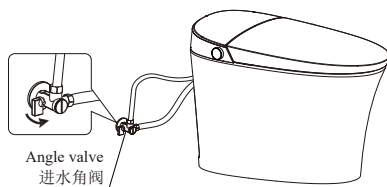

## 2. Switch the power supply

Insert electric leakage protection plug into power socket, protection switch, indicator light is on which means there is electricity. Press electric leakage test button prior to usage, protection switch bounces to show that protection function works normally.

## 2. 接通电源

电源线漏电保护插头插入电源插座, 按下复位开关, 插头指示灯亮, 表示通电。

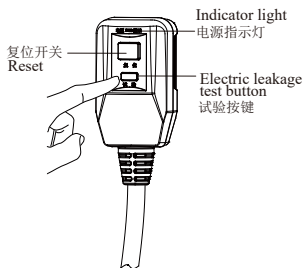

Tips: Press electric leakage test button prior to usage, protection switch bounces to show that protection function works normally.

温馨提示: 使用前先按下漏电试验按键, 复位开关弹起, 指示灯熄灭, 表示漏电保护功能正常。

## 3. Self-inspection

- ※ The buzzer of the main unit beeps, the self-test starts;
- ※ The buzzer of the main unit beeps again, the self-test is completed;
- ※ Function mode is on to enter normal usage.

## 3. 安全自检

1. 主机蜂鸣器一声“嘀”, 开始自检;
2. 主机蜂鸣器再响一声“嘀”, 自检完毕;
3. 功能模式开启, 正常使用。

## FOOT SENSING FUNCTION

## 脚感应功能

1. When the seat and cover are both closed, touch the sensing area with your foot to open the cover.
2. When the cover is open and seat is closed, touch the sensing area with your foot to open the seat.
3. When the seat and cover are both open, touch the sensing area with your foot to close the seat and cover and activate a half flush.

1. 当便盖和座圈均闭合，用脚触碰感应区域，打开便盖；
2. 当便盖打开、座圈闭合，用脚触碰感应区域，打开座圈；
3. 当便盖和座圈均打开，用脚触碰感应区域，自动关闭座圈和便盖后，进行半排冲水。

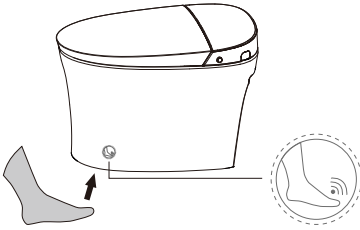

## ACTIVATE FOAM SHIELD

## 启动泡沫盾

Before starting the foam shield for the first time, use the "pump" command to pump the foam agent into the foam shield.

首次启动泡沫盾前，需要使用“抽液”指令先将泡沫剂抽至泡沫盾内。

Long press the button of the remote control until it is released after bubbling out of the outlet, that is, the "pumping" action is completed



长按遥控器此按钮不松开，直至出泡口出泡后松开，即完成“抽液”动作

### Warm tips:

1. It is normal to use the foam shield for the first time after executing the "pumping" instruction.
2. This operation is only used when the toilet has just been installed or the foam agent has been used. The foam agent will be wasted when used in other periods.

### 温馨提示:

1. 执行“抽液”指令后，首次使用泡沫盾有可能存在泡沫量大，属于正常现象；
2. 该操作仅在马桶刚安装或泡沫剂使用完毕更换泡沫剂时使用，其余时段使用将造成泡沫剂浪费。

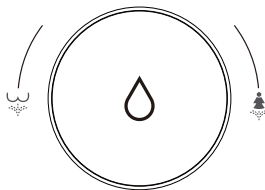

## Instruction of knob:

[POWER ON] Standby and without seated, short press the button to power on.

[STANDBY] Press and hold the knob to enter standby mode.

[FLUSHING] Switch on → Short pressing knob (When rear washing, front washing, warm air and nozzle washing are turned off) → Flushing

[REAR CLEANING] Switch on → First time on the seat → Turn the knob backwards to start rear cleaning → Short press the knob to automatically enter the warm air function and flushing function after rear cleaning → Automatic stop. Keep the seat, open the rear cleaning again, short press the knob during the cleaning process, then stop cleaning, open the warm air function, do not open the flushing function. In the rear cleaning process, rotate the knob forward/back to adjust the position of the spray rod and the strength of the water pressure; Long press the knob to switch the position of the spray rod and the strength of the water pressure.

[FEMININE CLEANING] Switch on → First time on the seat → Turn the knob forward to start feminine cleaning → Short press the knob to automatically enter the warm air function and flushing function after feminine cleaning → Automatic stop. Keep the seat, open the feminine cleaning again, short press the knob during the cleaning process, then stop cleaning, open the warm air function, do not open the flushing function. In the feminine cleaning process, rotate the knob forward/back to adjust the position of the spray rod and the strength of the water pressure; Long press the knob to switch the position of the spray rod and the strength of the water pressure.

[NOZZLE CLEANING] Switch on, on standby mode, Turn the knob forward, nozzle extends out → Hand cleaning → Short pressing the knob, nozzle retracts and stop cleaning.

[STOP] When the functions such as rear wash, front wash, drying, nozzle cleaning are turned on, short press the button to stop the current function immediately.

## Remark:

The default position of all function positions just set is in the middle position. When using the remote control, switch to the function position set by the remote control.

## 旋钮操作说明:

[工作模式] 待机且未着座状态, 短按旋钮, 进入工作模式

[待机模式] 长按旋钮, 进入待机模式

[冲水] 工作模式 → 短按旋钮 (未开启臀洗、妇洗、暖风及喷嘴清洗时) → 冲水

[臀洗] 工作模式 → 首次着座 → 向后旋转旋钮, 开启臀洗 → 短按旋钮, 结束臀洗后自动进入暖风功能及冲水功能 → 自动停止。保持着座, 再次开启臀洗时, 清洗过程中短按旋钮, 则停止清洗, 开启暖风功能, 不开启冲水功能。臀洗过程中, 向前/后旋转旋钮, 可调节喷杆位置和水压强弱; 长按旋钮进行喷杆位置和水压强弱的切换。

[妇洗] 工作模式 → 首次着座 → 向前旋转旋钮, 开启妇洗 → 短按旋钮, 结束妇洗后自动进入暖风功能及冲水功能 → 自动停止。保持着座, 再次开启妇洗时, 清洗过程中短按旋钮, 则停止清洗, 开启暖风功能, 不开启冲水功能。妇洗过程中, 向前/后旋转旋钮, 可调节喷杆位置和水压强弱; 长按旋钮进行喷杆位置和水压强弱的切换。

[喷嘴清洁] 工作模式, 无着座状态下, 向前旋转旋钮, 喷杆伸出 → 手动清洗 → 短按旋钮, 喷杆缩回, 结束清洗。

[结束] 臀洗、女用、暖风、喷嘴清洁开启时, 短按按键可立即停止当前功能。

温馨提示: 刚开机所有功能档位默认位置设置在中间档, 当使用遥控器后, 切换到遥控器设定的功能档位。

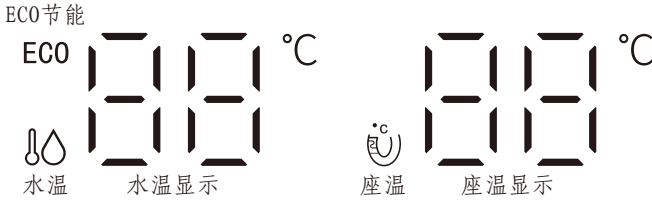

#### Description of LED light on display:

1. In the non-power-saving state, the ICONS of default seat temperature and water temperature light up to display the current seat temperature and water temperature, and display "--" when in neutral;
2. Under the power saving state, the ICONS of ECO, seat temperature and water temperature are lit. If the seat temperature is in neutral before power saving, "--" will be displayed when entering power saving; if the seat temperature is not in neutral before power saving, it will be displayed in one gear when entering power saving; Keep the current water temperature display;
3. Shutdown, the screen display all out;
4. When no one is in use, the screen display will all be off after some time; When someone is sitting or operating any button of the product, the screen will restore the current state;

#### 显示屏LED灯说明:

- 1、在非节能模式下，默认座温、水温图标亮起，显示当前座温、水温温度，空档时显示“--”；
- 2、节能模式下，ECO、座温、水温图标点亮，座温节能前若为空档，则进入节能时显示“--”，节能前若非空档，则进入节能时显示一档；水温显示保持当前状态；
- 3、待机模式时，屏幕显示全部熄灭；
- 4、无人使用状态下，一段时间后屏幕显示全部熄灭；当有人着座时或操作产品任意按键，屏幕则恢复显示当前状态；

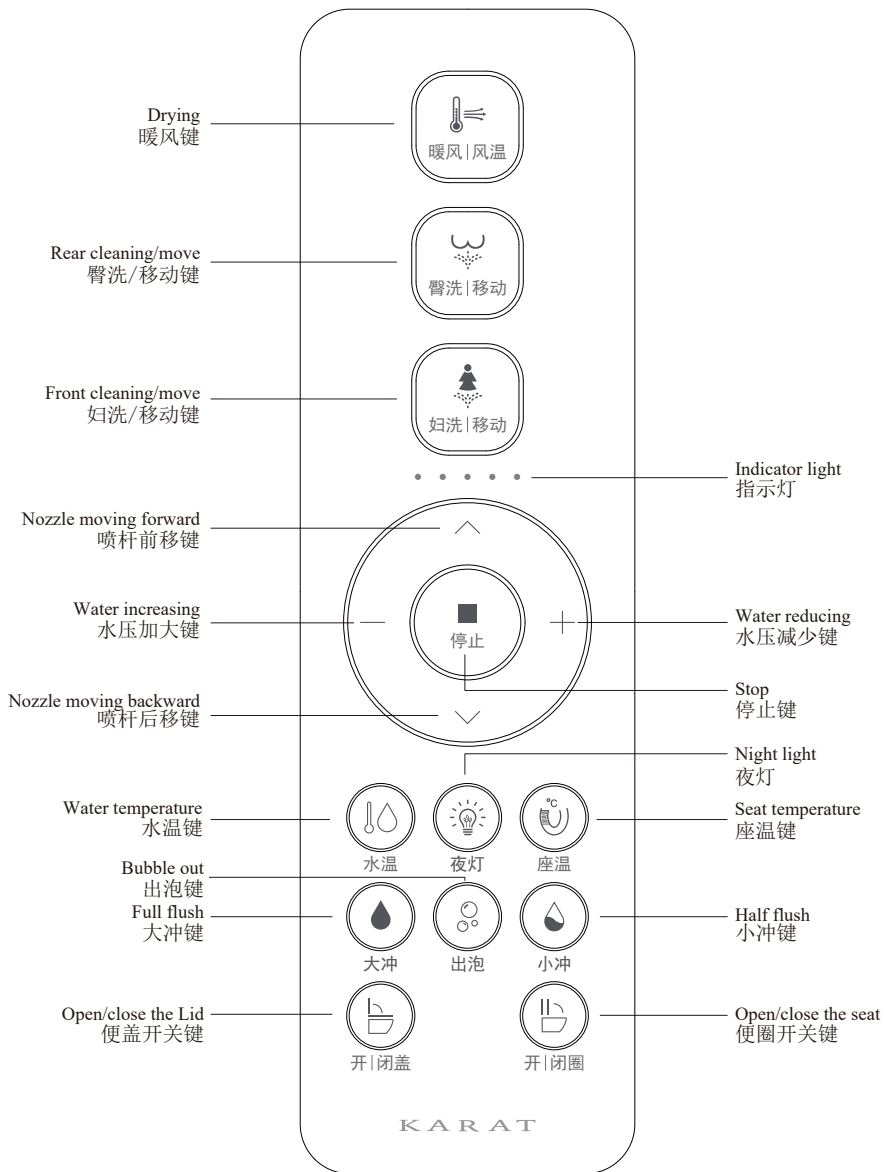

## Rear/Front cleaning

Press "👤" button, the indicator light is on showing current water temperature level, it starts spraying to clean the buttocks ; it will stop drying automatically after a circle of 180 seconds ; If you press the "■" button midway, you can stop cleaning immediately.

Press "👤" button, the indicator light is on showing current water temperature level, it starts spraying to clean the front ; it will stop drying automatically after a circle of 180 seconds ; If you press the "■" button midway, you can stop cleaning immediately.

## 臀洗/妇洗操作

按一下“👤”键，指示灯亮起，显示当前水温档位，喷水清洗臀部，再按一下则切换到移动清洗（喷嘴前后移动，扩大洗净范围），持续清洗一个周期约180秒后自动停止，若中途按下“■”键，可立即停止清洗。

按一下“👤”键，指示灯亮起，显示当前水温档位，喷水清洗妇部，再按一下则切换到移动清洗（喷嘴前后移动，扩大洗净范围），持续清洗一个周期约180秒后自动停止，若中途按下“■”键，可立即停止清洗。

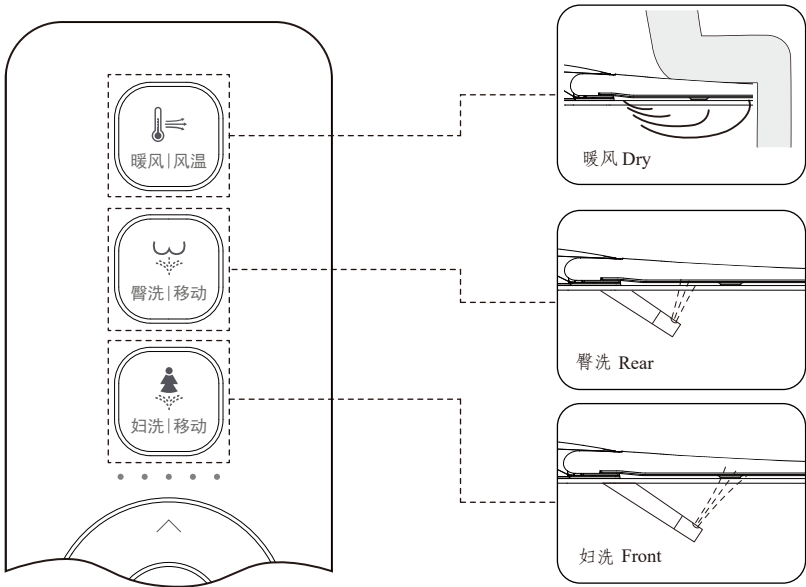

## Drying Operation

① Press the "🌡️" button, the indicator light will light up, showing the current air temperature range. It will stop drying automatically after a cycle or after the human body leaves the seat.

② In the process of drying, press the "🌡️" button to adjust the air temperature, and the indicator light will light up to display the wind temperature range. When the indicator light is not on, it is 0 grade (normal temperature range), and the range adjustment mode is 0-5 grade in turn.

○ ○ ○ ○ ○	● ○ ○ ○ ○	● ● ○ ○ ○	● ● ● ○ ○	● ● ● ● ○	● ● ● ● ●
常温 Normal temperature	第1档 Grade 1	第2档 Grade 2	第3档 Grade 3	第4档 Grade 4	第5档 Grade 5

## 暖风操作

① 短按“🌡️”键，指示灯亮起，显示当前风温档位，暖风吹出，一个周期后或人体离开座圈后，自动停止暖风。

② 在暖风过程中，短按“🌡️”键调节风温，指示灯亮起显示风温档位，指示灯不亮时为0档（常温档），档位调节方式为0-5档依次循环。

## Spray nozzle position adjustment

Press "∧" or "∨" button when it is under function of rear cleaning or front cleaning, the indicator light will be on showing current nozzle position, adjust nozzle position by 5 levels.

## 喷嘴位置调节

在“臀洗”或“妇洗”时，短按喷嘴位置“∧”，“∨”键，指示灯亮起，显示当前喷嘴档位，可在5档之间调节喷嘴位置前移、后移。

## Water volume adjustment

Press "+" or "-" button when it is under function of rear cleaning or front cleaning, the indicator light will be on showing current water volume level, adjust water volume by 3 levels.

## 水压调节

在“臀洗”或“妇洗”时，短按水压“+”，“-”键，指示灯亮起，显示当前水压档位，调节水压大小。

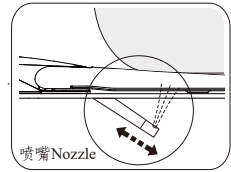
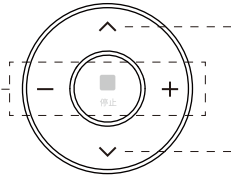
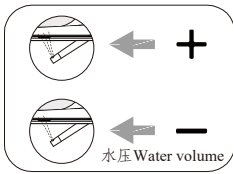

## Water temperature adjustment

Short press the "🌡️" button to adjust the water temperature. The indicator will show the water temperature level if it's on. When the indicator is off, the water level is 0. Short press this button to adjust water temperature level from 0 to 5 in cycle.

## 水温调节

短按“🌡️”键调节水温，指示灯亮起显示水温档位，指示灯不亮时为0档(常温档)，档位调节方式为0-5档依次循环。

○ ○ ○ ○ ○

常温  
Normal  
temperature

● ○ ○ ○ ○

第1档  
Grade 1

● ● ○ ○ ○

第2档  
Grade 2

● ● ● ○ ○

第3档  
Grade 3

● ● ● ● ○

第4档  
Grade 4

● ● ● ● ●

第5档  
Grade 5

## Seat temperature adjustment

Short press the "🪑" button to adjust the seat temperature. The indicator will show the seat temperature level if it's on. When the indicator is off, the seat level is 0. Short press this button to adjust seat temperature level from 0 to 5 in cycle.

## 座温调节

短按“🪑”键调节座温，指示灯亮起显示座温档位，指示灯不亮时为0档(常温档)，档位调节方式为0-5档依次循环。

○ ○ ○ ○ ○

常温  
Normal  
temperature

● ○ ○ ○ ○

第1档  
Grade 1

● ● ○ ○ ○

第2档  
Grade 2

● ● ● ○ ○

第3档  
Grade 3

● ● ● ● ○

第4档  
Grade 4

● ● ● ● ●

第5档  
Grade 5

## Night light

· Night light adjustment: Short press "💡" button to turn on/turn off night light.

· Smart mode: Long press "💡" button to enter into intelligent mode (Night light will be on or off by detecting the lightness of surroundings). If the product is on intelligent mode, short press "💡" button to exit intelligent mode. (Night light factory default setting is intelligent mode)

## 夜灯设置

· 夜灯调节: 短按“💡”键，开/关夜灯。

· 智能模式: 长按“💡”键进入智能模式(依外界环境明/暗自动开/关夜灯)，若处于智能状态，短按“💡”键退出智能模式。(夜灯出厂默认设置为智能模式)

## Half flush/Full flush

- Short press "💧" button, the toilet starts half flushing.
  - Short press "💧" button, the toilet starts full flushing.
  - Long press "💧" button to turn on/off auto flush function.
- When the auto flush function is turned on, toilet will automatically flush after detecting user leaving the seat.



## 冲水功能

- ①短按“💧”键，启动半冲功能，马桶开始半排水。
  - ②短按“💧”键，启动全冲功能，马桶开始全排水。
  - ③长按“💧”键，开启自动冲水功能，蜂鸣器“嘀”响一声；
  - ④再次长按“💧”键，关闭自动冲水功能，蜂鸣器“嘀”响二声；
- 在开启自动冲水功能后，离座时会进行大/小冲功能。

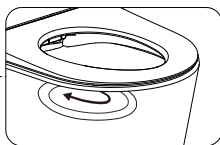

## Open/Close by remote controller

- Short press "🪑" button, open or close the lid.
- Short press "🪑" button, open or close the seat.

## 遥控翻盖

- ①短按“🪑”键，打开或关闭便盖。
- ②短按“🪑”键，打开或关闭座圈。

## Bubble out setting

- ① Press "🌀" to enable the foam shield function.
- ② Long press the "🌀" to start the rapid pumping of the foam shield until the bubble emerges from the bubble outlet and then release the "🌀" key. (Note: This operation is only used when the toilet has just been installed or the foaming agent has been used, and the foaming agent will be wasted when used in other periods)
- ③ Press the "■" key first, and press the "🌀" key, start the automatic bubble function, the buzzer "beep" sound;

Press the "■" key again, and then press the "🌀" key to turn off the automatic bubble function, the buzzer "beep" twice.  
(Automatic bubbling function is disabled by default)

## 出泡设置

- ①短按“🌀”键，开启泡沫盾功能；
- ②长按“🌀”键，开启泡沫盾的快速抽液，直至出泡口出泡后松开“🌀”键。  
(注意：该操作仅在马桶刚安装或泡沫剂使用完毕再次添加起泡剂时使用，其余时段使用将造成泡沫剂浪费)
- ③先按“■”键，并按下“🌀”键，开启自动出泡功能，蜂鸣器“嘀”响一声；再次按“■”键，并按下“🌀”键，关闭自动出泡功能，蜂鸣器“嘀”响二声。  
(自动出泡功能默认关闭)

## Automatic pre-wetting button

Press and hold the "■" button and press the "💧" button to turn on or off the automatic pre-wetting function. After the automatic pre-wetting function is turned on, the pre-wetting function is performed when the user is detected to be seated.

## 自动预湿润

先按住“■”键，并按下“💧”键，开启自动预湿润功能，蜂鸣器“嘀”响一声；再次按住“■”键，并按下“💧”键，关闭自动预湿润功能，蜂鸣器“嘀”响二声；在开启自动预湿润功能后，当检测到用户着座时，会进行陶瓷预湿润功能。

## Quite mode

Press and hold the "■" button and press the "👤" button to turn on/off quite mode.



## 静音开关

先按住“■”键，并按下“👤”键，开启或关闭静音功能。



## Foot sense switch

Long press "  " button to turn the foot sense function on or off. In the seated status, foot sense function is invalid.

## 脚感开关

长按 " " 键, 开启脚感功能, 蜂鸣器“嘀”响一声; 再次长按 " " 键, 关闭脚感功能, 蜂鸣器“嘀”响二声; 在着座状态下, 脚感无效。



## Energy saver

Long press "  " button to enter energy saving mode, long press "  " button again to exit energy saving mode.

### Energy saving

Under energy saving mode, seat temperature is low(level 1) to achieve energy saving.(Note: If the seat temperature before energy saving is neutral, keep the neutral after energy saving)

## 节能设置

- ①长按 " " 键, 开启节能模式, 蜂鸣器“嘀”响一声;
- ②再次长按 " " 键, 关闭节能模式, 蜂鸣器“嘀”响二声;

### 节能模式下说明:



设定节能后, 在节能模式下, 座温处于低温状态(第一档温度)以达到节能的目的。(注: 节能前座温若为空档, 节能后保持空档)  
节能时如果中途有人使用座圈, 节能模式暂停, 进入功能模式, 座圈立即开始加热(不关闭座温情况下), 人体离开座圈后, 即恢复节能模式。



## User code



(Tips: When multiple hosts are placed together, code alignment is required to avoid interference of remote control operation before each host)

- ① Plug in the toilet. It will execute self-inspection.

When finished, it beeps once.

- ② First press "  " button, then press "  " button, the indicator light will flash.







- ③ Press the Pressure "  " or "  " button to select user 1-9 (as shown the figure below). The indicator light displays the corresponding user code and flashes.

- ④ Press "  " button, then press "  " button. The main unit beeps once, means the remote control and the toilet are matched successfully.

- ⑤ After the host is powered off, power on the host again. If the remote control has alignment codes before, remove the battery of the remote control so that the remote control codes return to zero before re-alignment

## 用户对码

(温馨提示: 多台主机放置一起时为避免各台主机之前遥控操作干扰才需对码)

- ①主机电上电自检完后“嘀”一声;
- ②先按住 " " 键再按下 " " 键, 指示灯闪烁;
- ③按下水压 "  " 或 "  " 键来选择用户码1-9 (如下图所示), 指示灯显示对应用户码并闪烁;
- ④再次先按住 " " 键再按下 " " 键, 主机“嘀”一声, 对码成功。
- ⑤主机断电后重新上电, 如果之前遥控器有对码, 需将遥控器电池拆下使遥控器码数归零后才能按对码步骤重新对码;

● ● ● ● ●	○ ● ● ● ●	○ ● ● ● ●
用户1	用户2	用户3
User 1	User 2	User 3
○ ● ● ● ●	○ ● ● ● ●	○ ○ ● ● ●
用户7	用户8	用户9
User 7	User 8	User 9

○ ○ ○ ● ○	○ ○ ○ ● ●	● ● ● ● ○
用户4	用户5	用户6
User 4	User 5	User 6

## Tips

· The buzzer will sound “BEEP” when the user presses one button which means the main unit receives the signal and conduct the operation accordingly. If the buzzer doesn't sound, it means the main unit doesn't receive the signal, please adjust the remote control direction and repress the button.

· In case of power cut during nozzle spray operation, the nozzle cannot go back to place, please wait until the power is reset. In case of a power cut for a long period, please push the nozzle softly back by hand. Do not push hard, to avoid damage to nozzle and electrical machine.

## 温馨提示

· 每次按按键, 蜂鸣器“嘀”响一声, 表示主机接收到信号, 并执行信号。如果蜂鸣器未响, 表示主机未接收到信号, 请调整遥控器发射方向重新按按键。

· 在喷洗过程中, 突然停电, 喷杆无法缩回, 请等待来电重新开机, 喷杆会自动收回。若长时间断电且需要使用马桶, 可轻轻用手将喷杆推回。请勿用力推拉喷杆, 以免损坏喷杆和电机。

Remote control hanger installation 1:

1. Drill a 6 mm diameter hole in the wall to a depth of about 35 mm.
2. Tear off the double-sided adhesive sticker on the back of the hanger.
3. Install the expansion pipe into the wall hole, and align it with the hanger hole. Attach the double-sided adhesive sticker on the back of the hanger to the wall, lock the screw, and tear off the double-sided adhesive sticker on the back of the patch and stick it on.

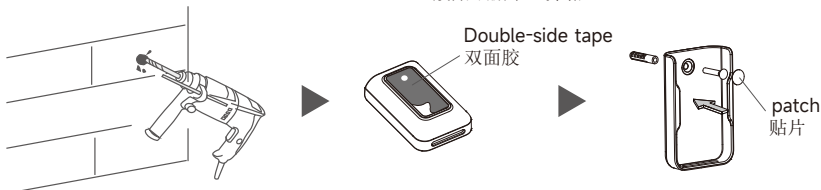

遥控器挂架安装方式一

- 1、在墙壁钻一个直径为6mm的孔，深度约35mm。
- 2、将挂架背面双面胶贴纸撕下。
- 3、将膨胀管装入墙孔内，挂架孔对准膨胀管，把挂架背面的双面胶紧贴在墙壁上，锁紧螺钉，将贴片背面双面胶贴纸撕下，并黏上。

Remote control hanger installation 2:

1. Clean and wipe dry the pre-installed area of the remote control hanger on the wall.
2. Tear off the double-sided adhesive sticker on the back of the hanger.
3. Stick to the wall vertically, tear off the double-sided adhesive sticker on the back of the patch and stick it on.

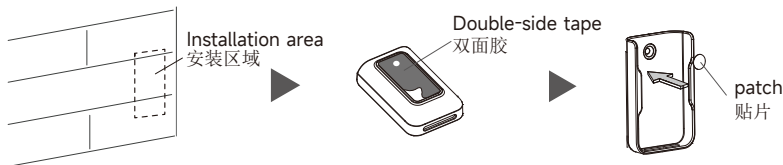

遥控器挂架安装方式二

- 1、清洁并擦干墙上遥控器挂架预安装的区域。
- 2、将挂架背面双面胶贴纸撕下。
- 3、竖直贴紧墙壁，将贴片背面双面胶贴纸撕下，并黏上。

Battery installation:

1. Install the new battery into the remote control and cover the battery cover.
2. Put the remote control in the hanger.



安装电池:

- 1、将新电池装入遥控器，盖上电池盖。
- 2、将遥控器放入挂架中。

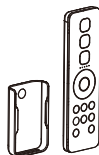

电池型号: LR03 / AAA 型 / 7 号碱性干电池

⚠ Battery installation and use precautions:

- ①. The original dry cell batteries are non-rechargeable. Do not recharge them.
- ②. Insert the batteries according to the "+" and "-" markings in the battery compartment. Do not insert them in reverse.
- ③. Remove exhausted batteries and dispose of them safely. Do not discard them carelessly.
- ④. Do not heat or disassemble the battery, or dispose of it in water or fire.
- ⑤. Do not connect the "+" and "-" terminals with metal wire, etc., and do not place it together with metal necklaces, hairpins, etc.
- ⑥. Do not mix old and new batteries, or batteries of different models or brands.
- ⑦. Do not use batteries with peeling casings, and do not use rechargeable batteries instead of dry cells.
- ⑧. When not in use for an extended period, remove the batteries from the product and store them securely, keeping them out of the reach of infants and young children.

Notice: 1. When determining the installation position, it is necessary to ensure that the remote control can be reached by hand when the person is sitting on the ring.  
2. It is forbidden to install and use the product in the bathroom and other wet places. And do not put it in the place where it is easy to be drenched by water.

⚠ 电池安装使用注意事项:

- ①. 原配干电池为不可充电电池，请勿对干电池进行充电。
- ②. 请按照电池仓内的“+”和“-”标志装入电池，请勿装反。
- ③. 电池用尽应取出，并进行安全处置，请勿随意丢弃。
- ④. 请勿对电池进行加热、拆分，请勿放入水里或火里。
- ⑤. 请勿用金属丝等连接“+”和“-”极，请勿与金属制的项链、发夹等放置在一起。
- ⑥. 新旧电池不可混用，不同型号、不同品牌电池不可混用。
- ⑦. 请勿使用外壳已剥落的电池，请勿以充电电池代替干电池使用。
- ⑧. 长期不使用，请将产品内的电池取出并妥善保管，请勿置于婴幼儿能碰到的地方。

提示: 1、确定安装位置时，需注意当人坐在座圈上，保证手可以拿到遥控器。  
2、请勿在浴室等潮湿的地方安装使用产品，禁止置于易被水淋到的地方。

Main unit care and maintenance

1. Shut off power supply at maintenance.
2. Turn the seat upward open, press down the button located on the right side of main unit and pull out the seat. Wipe the stain with a soft damp cloth.
3. Safety self- inspection  
After cleaning, re-connect the toilet with the power supply.

产品的保养

1. 切断电源  
产品保养时请先切断电源。
2. 柔软抹布擦拭  
请用拧干水分的柔软抹布擦拭脏污部位。
3. 安全自检  
擦拭完成后请重新接上电源。

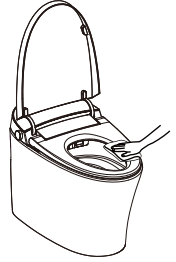

Spray nozzle maintenance and care

1. Nozzle self-cleaning  
Before or after rear and feminine cleaning, the nozzle starts self-cleaning and stops automatically after a period of self-cleaning.
2. Nozzle manual cleaning
  - The nozzle out  
User not seated, the knob turn forward to start the nozzle manual cleaning function, and the nozzle will automatically extend and the washing water flow out of cleaning spray rod.
  - Spray nozzle disassemble  
When the wand moves forward, the nozzle can be disassembled to clean.  
Note: When disassembling the nozzle, use one hand to fix the wand and the other hand to pull down the nozzle to avoid forcibly pulling the nozzle to prevent damage to the wand.
  - Use soft cloth or soft brush to clean  
Do not pull or push the wand, to avoid damage.
  - Nozzle assembly  
Put the nozzle back to the front of the boom and press the "Stop" button to automatically retract the nozzle.

喷嘴的保养

- 1、喷嘴自洁  
每次臀洗、妇洗开启前或臀洗、妇洗结束后，喷嘴自动流水自洁一段时间后自动停止。
- 2、喷嘴手动清洗
  - 喷嘴伸出  
人体无着座，旋钮向前旋转启动喷嘴手动清洗功能，喷嘴会自动伸出并有自洁水流出清洗喷杆。
  - 喷嘴拆卸  
喷嘴自动伸出以后，可拆下喷嘴头部清洗。  
注意：拆喷嘴时，一只手固定喷杆，另一只手将喷嘴拉下。避免强行拉扯喷嘴，以防损坏喷杆。
  - 请用柔软抹布或软毛刷擦拭  
请勿将喷杆外拉或内推，以免破坏喷杆或电机。
  - 收回喷嘴  
将喷嘴头部装回喷杆前端，短按旋钮启动停止功能，喷嘴自动收回。

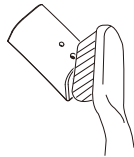
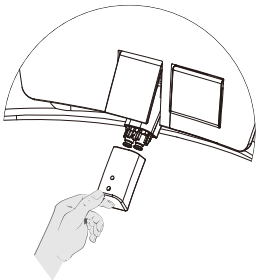

## MAINTENANCE OF FILTER NET

## 过滤阀芯的保养

Time for maintenance: It is under normal water pressure but poor flush occurs.

1. Turn off power and the angle valve
2. Unscrew angle valve nut
3. Remove filter net
4. Use the brush to clean filter net
5. Reinstall filter net and angle valve nut
6. Turn on the angle valve and connect power, then it can work normally after self inspection.

\*It is recommended that you clean the filter once in 1-2 months

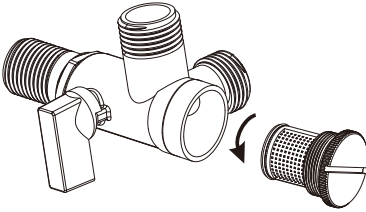

保养时机：当水压正常但冲刷效果不佳时。

1. 断开电源，关闭角阀
2. 旋开角阀螺母
3. 取出过滤阀芯
4. 用牙刷刷洗，清水冲去阀芯内泥沙
5. 装回过滤阀芯，重新安装角阀螺母
6. 打开角阀，接通电源，自检完毕后即可正常使用。

\*建议1-2月清洗一次过滤网

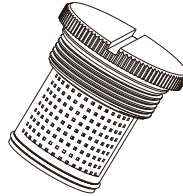

## EMERGENCY TROUBLESHOOTING

## 紧急情况

### Electricity and water supply cut-off

1. Power failure  
Press the manual flushing button to flush the toilet.
2. Water failure  
Put around 8L water into a barrel and flush the bowl of ceramic.  
Note: Avoid water spilling from bowl.

### 停电停水

1. 停电时冲洗坐便器的方法  
按下手动冲刷按键，进行冲洗。
2. 停水时冲洗坐便器的方法  
将水放入较大的水桶（约8L）内，以坐便器槽面为中心进行冲洗。此时，注意防止水从坐便器溢出。

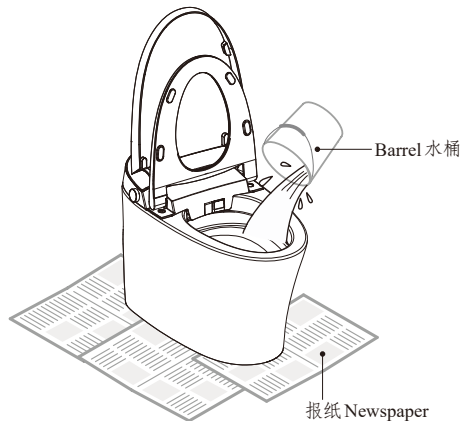
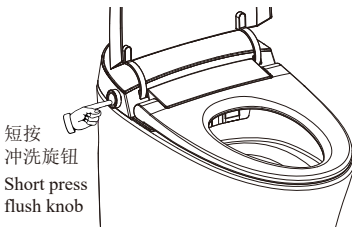

## Bidet seat battery installation and replacement

### Tips:

- It is recommended to ask professional personnel to operate!
- When the product does not perform the flushing function after short or long pressing of the knob and the night light blinks for 10 consecutive times, it indicates that the flushing battery is about to run out of power and a new battery needs to be updated.
- Please use 9V alkaline battery (6LR61). It is recommended to replace the battery every two years.
- Please refer to page 22 for detailed instructions on battery installation and use.

1. Pull out the power plug and turn off the angle valve;
2. Fully open the seat and cover, remove decorative caps, screws and washers.

3. Pull up the bidet seat slightly with both hands in the vertical direction, so that the back end is separated from the ceramic positioning rod. (It is normal to have a "click" sound during the pulling process.)
4. Pull out the connecting wire, loosen the silicone tube connected with ceramic foam shield on the cover plate, screw into the water hose, and take out the electronic cover plate;

5. With the front of the electronic cover plate upwards, unscrew the nut of the foam shield liquid storage bottle, collect the foam agent in the liquid storage bottle with the container (capacity greater than 600ml), and lock the liquid storage bottle with the nut when there is no foam agent in the liquid storage bottle. (Add this operation if there is no sealing plug at the filling port)

## 冲刷电池的更换方法

### 温馨提示:

- 进行此步骤时，建议请专业人员进行操作！
- 当短按或长按旋钮后产品未执行冲水功能并且夜灯连续闪烁10次时，表示冲水电池电量即将耗尽，需要重新更新新电池。
- 请使用9V碱性电池（6LR61），电池建议每隔2年更换一次。
- 电池安装使用注意事项详见第22页。

1. 拔出电源插头，关闭角阀；
2. 完全打开座圈和便盖，取出左右两边的装饰盖，旋出螺钉（逆时针方向），并取出垫片；

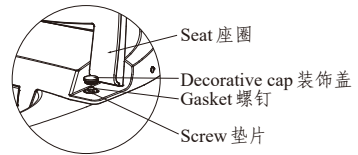

3. 双手小幅度沿竖直方向上拉盖板，使盖板后端脱离陶瓷定位柱（拔起过程中有“咔嗒”声音为正常现象）；
4. 拔出对插连接线，松开盖板上泡沫盾连接陶瓷的硅胶管，旋开进水软管，取出电子盖板；

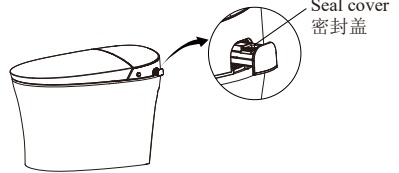

5. 电子盖板正面朝上，旋开泡沫盾储液瓶的螺母，用容器（容量大于600ml）收集储液瓶中的泡沫剂，待储液瓶中无泡沫剂后用螺母锁紧储液瓶。（若加液口没有密封塞，则需增加此操作）

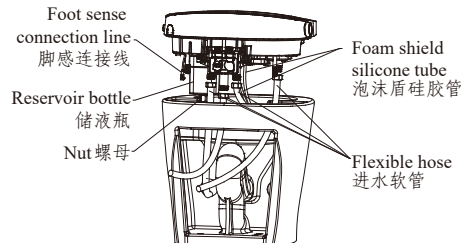

- Place the bidet seat flat on the workbench with the bottom facing up. (Please use a blanket or other soft material to cushion the bidet seat to avoid scratching.)
- Remove the battery box cover from the bottom to install or replace the battery.
- Plug the cover plate of the replaced battery into the connecting cable, install the foam shield silicone tube, tighten the water inlet pipe, and then put it back on the toilet. Then add the foam agent in the container to the electronic cover plate through the liquid pumping box ( If there is step 5, then the filling step needs to be performed). Last open the Angle valve and power on again. (Note: The blue silicone tube is connected to the thinner interface, and the transparent silicone tube is connected to the thicker interface.)

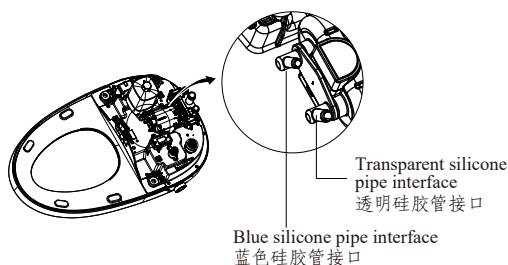

- 将盖板平放在工作台上，底部朝上放置(请用毛毯或其他柔软物垫盖板，避免更换过程中划伤盖板外观)；
- 从盖板底部拆下电池盒盖，更换冲厕电池；
- 将换好电池的盖板插上对插连接线，装上泡沫盾硅胶管，旋紧进水管，再装回马桶上；然后将容器中的泡沫剂通过加液抽拉盒添加到电子盖板中（若有第5步骤，则需进行加液步骤）；最后打开角阀，重新上电。（注：蓝色硅胶管接较细的接口，透明硅胶管接较粗的接口。）

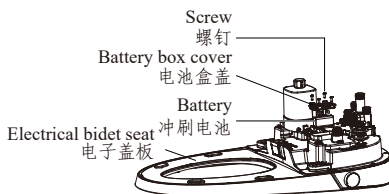

#### When the product is left unused for long time

- Especially in winter when no one at home for a long time, please drain out the water inside ceramic and pipe to prevent freezing.

#### 长时间不使用时

- 尤其是冬季，长期不在家时，请务必将陶瓷及管路中的水放掉，防止冻结。

#### To discharge water

- Cut off the electricity .
- Drain out the water inside tank  
Turn off angle valve, flush all water inside by pressing and holding manual flush button.
- Drain out the water inside pipe  
Unscrew the hose connector off angle valve, drain the water in the pipe and reinstall.
- Handle the remaining water in bowl  
It is suggested to put some antifreeze into water inside the bowl.

#### 放水的方法

- 拔出电源插头，切断电源
- 将马桶水箱中的水排空  
关闭进水角阀，长按手动冲厕按键将水排空。
- 将管路中的水排空  
将软管从角阀上旋开，排空管路的水后重新装回。
- 处理便器内积水  
为了安全起见，建议将防冻液放入便器内的积水中。

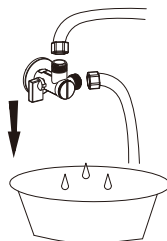

Tips: When you use this device again please do reconnect to water and power supply.

温馨提示：再次使用坐便器时，请务必再次通水、通电。

**⚠️** Note: Before water discharging, the power must be cut off!

**⚠️** 注意：在电子坐便器放水前，必须切断电源！

Problem	Cause	Solution
No flushing	Water supply hose buckling causes block	Solve the buckling
	Fill valve is off	Turn on the fill valve
	Water supply is cut off	Connect water supply and wait for the water
Poor flushing	Water supply hose buckling causes partial block	Solve the buckling
	Fill valve is not fully turned on	Turn on the fill valve fully
	Filter is dirty and causes block	Clean the filter
The water is not hot	The water temperature is setted on normal temperature level	Reset the water temperature
Seat temperature is not hot	The seat temperature is setted on normal temperature level	Reset the seat temperature
	In standby mode	Shift to function mode for 3 minutes
Wind temperature is not hot	The wind temperature is setted on normal temperature level	Reset the wind temperature
No wind out	In standby mode	Shift to function mode to use dry function
spray wand cannot retracted	Power off	Push back the wand lightly and wait for the power
	Get stuck by impurities	Clear away the impurities
Spray wand cannot stretch out	Power off	Push back the wand lightly and wait for the power
	Do not sit in sensing area	Sit right in the sensing area
Controller cannot display	Reverse the polarity of battery	Reload the battery
	Batteries cannot supply enough power	Replace new batteries
When power is off, there will be no flush by pressing knob	battery out of power	Take E bidet off of the toilet, open the battery box lid from the bottom of E bidet and replace the battery
The foaming volume of foam shield is small	The foam agent is used up	Adding foam agent
After adding the foam agent, the foam shield foaming amount is small	After the foam agent is used up, there is air in the foam shield line	Execute the "pumping" instruction to extract the solution in the foam agent into the foam shield;

现象	原因	处理
不喷水	进水管弯折造成堵塞	排除进水软管弯折
	进水阀关闭	打开进水阀
	自来水断水	等待来水
喷水强度弱	进水管弯折造成部分堵塞	排除进水软管弯折
	进水阀未完全打开	完全打开进水阀
	进水滤网阻塞	清洗进水滤网
水温不热	水温设定常温档	重新设定水温档位
座温不热	座温设定常温档	重新设定座温档位
	处于待机模式	切换到功能模式3分钟后使用
风温不热	风温设定常温档	重新设定风温档位
不出风	处于待机模式	切换到功能模式使用暖风功能
喷杆不缩回	断电	将喷杆轻轻推回，等待来电
	被异物卡住	清除异物
喷杆不伸出	断电	等待来电
	未坐到着座感应区	位置坐正，坐到感应区
遥控器不显示	遥控器电池正负极装反	重新装电池，对准正负极
	遥控器电池电量不足	更换新电池
停电后，按压本机旋钮不冲水	冲刷电池电量不足	拆下电子盖板，从电子盖板底部拆开电池盒盖，进行更换冲刷电池
泡沫盾出泡量小	泡沫剂用完	添加泡沫剂
添加泡沫剂后，泡沫盾出泡量小	泡沫剂用完后，泡沫盾管路里存在空气	执行“抽液”指令将泡沫剂内溶液抽取进泡沫盾；

⚠ 注意：如果按上述方法处理后故障仍未排除，应切断电源，联系服务商，请专业人员维修。  
如果电源漏电保护开关时常跳开，表示产品有漏电，请切断电源，联系服务商，请专业人员维修。

## CONTACT INFORMATION

## 联系信息

Shanghai Chehe Trading Co., Ltd.  
Address: Floor 2, No.126,128,130 Jiang Chang San Road, Jing An District, Shanghai, PRC.  
Tel: 400-920-8262  
Postcode: 200436

上海澈和贸易有限公司  
地址：上海市静安区江场三路126、128、130号2层  
电话：400-920-8262  
邮编：200436

## 产品中有害物质含量的说明

### 回收提示

本产品超过使用期限或经过维修无法正常使用后，不应随意丢弃，请交由有废弃电器电子产品处理资质的企业处理，正确的处理方法请查阅国家或当地有关废旧电器电子产品处理的规定。

### 有害物质统计表

部件名称	产品中有害物质的名称及含有的信息表									
	有害物质									
	铅 (Pb)	汞 (Hg)	镉 (Cd)	六价铬 (Cr(VI))	多溴联苯 (PBBs)	多溴 二苯醚 (PBDEs)	邻苯二甲酸 二正丁酯 (DBP)	邻苯二甲酸 二异丁酯 (DIBP)	邻苯二甲酸 丁苯酯 (BBP)	邻苯二甲酸二 (2-乙基) 己酯(DEHP)
塑料组件	○	○	○	○	○	○	○	○	○	○
控制类组件	×	○	○	○	○	○	○	○	○	○
PCBA 组件	×	○	○	○	○	○	○	○	○	○
电机类组件	×	○	○	○	○	○	○	○	○	○
导线类组件	○	○	○	○	○	○	○	○	○	○
进水组件	○	○	○	○	○	○	○	○	○	○
* 喷管组件	○	○	○	○	○	○	○	○	○	○
加热组件	×	○	○	○	○	○	○	○	○	○
* 遥控器组件	×	○	○	○	○	○	○	○	○	○
* 电池	○	○	○	○	○	○	○	○	○	○
* 陶瓷类组件	○	○	○	○	○	○	○	○	○	○
* 水箱组件	○	○	○	○	○	○	○	○	○	○

注1：○：表示该有害物质在该部件所有均质材料中的含量均不超出电器电子产品有害物质限制使用国家标准要求。

×：表示该有害物质至少在该部件的某一均质材料中的含量超出电器电子产品有害物质限制使用国家标准要求。

注2：以上未列出的部件，表明其有害物质含量均不超出电器电子产品有害物质限制使用国家标准要求。

\*：表示部分机型含有该部件。

注：本表格提供的信息是基于供应商提供的数据及瀚和公司的检测结果。本产品应用环保设计理念，在当前技术水平下，所有有害物质或元素的使用已经控制到了最低程度，瀚和公司将继续努力通过改善现有技术来减少这些物质的使用。



本产品的“环保使用期限”为10年，瀚和公司根据产品设计特性指定该期限。只有在本产品使用说明书所述的正常情况下使用本产品时，“环保使用期限”才有效。

1. Depending on the product you purchase, different products may be equipped with one or more of the following micro-power short-range radio transmitting devices. The use of micro-power short-range radio transmitting devices must comply with relevant national radio management regulations. This product is only for use in home bathrooms.
  - ① The remote control belongs to "(I) General Micropower Equipment - Class 6.F Equipment" in the "Catalogue and Technical Requirements for Micropower Short-range Radio Transmitter Equipment". The antenna type is a PCB (printed circuit board) onboard antenna, and the power supply voltage is 2 or 3 PCS 1.5V dry batteries, 3.7V lithium batteries, 3V button batteries. For details, please refer to the battery installation and use instructions.
    - (1) Operating frequency: 2400-2483.5 MHz.
    - (2) Transmitting power limit: 10 mW (e.i.r.p).
    - (3) Frequency tolerance: 75 kHz.
  - ② Microwave sensors belong to "(I) General Micropower Equipment - Class 8.H Equipment" in the "Catalogue and Technical Requirements for Micropower Short-range Radio Transmitter Equipment". The antenna type is a PCB (printed circuit board) onboard antenna, and the power supply voltage is 5V.
    - (1) Operating frequency: 24-24.25 GHz.
    - (2) Transmit power limit: 20 mW (e.i.r.p).
2. It is not allowed to change the usage scenario or conditions, expand the transmission frequency range, increase the transmission power (including installing an additional RF power amplifier), or change the transmission antenna without authorization.
3. It shall not cause harmful interference to other legal radio stations, nor claim protection from harmful interference.
4. This device can withstand interference from industrial, scientific and medical (ISM) application equipment that radiates radio frequency energy or other legal wireless radio stations.
5. If harmful interference is caused to other legal radio stations, the use shall be stopped immediately and measures shall be taken to eliminate the interference before the use can be continued;
6. When using micro-power equipment in aircraft and in electromagnetic environment protection areas of radio astronomy stations, meteorological radar stations, satellite earth stations (including measurement and control, ranging, receiving, and navigation stations), other military and civilian radio stations (stations), airports, etc. established in accordance with laws, regulations, and relevant national provisions and standards, the regulations of the electromagnetic environment protection and relevant industry authorities shall be observed.
7. It is prohibited to use any model remote controller within a radius of 5,000 meters with the center of the airport runway as the center (this product does not involve model remote controllers).
8. The ambient temperature range for this device is 0°C to 40°C.

1. 根据购买的产品不同，不同的产品可能会配置以下一种或多种的微功率短距离无线电发射设备，使用微功率短距离无线电发射设备应当符合国家无线电管理有关规定，本产品仅限在家庭卫生间使用。
  - ①遥控器属于《微功率短距离无线电发射设备目录和技术要求》的“（一）通用微功率设备- 6.F 类设备”，天线类型为PCB（印刷电路板）板载天线，供电电压为2节或3节1.5V干电池；3.7V锂电池；3V纽扣电池，具体见电池安装使用说明。
    - （1）使用频率：2400-2483.5 MHz。
    - （2）发射功率限值：10 mW（e. i. r. p）。
    - （3）频率容限：75 kHz。
  - ②微波感应器属于《微功率短距离无线电发射设备目录和技术要求》的“（一）通用微功率设备- 8.H 类设备”，天线类型为PCB（印刷电路板）板载天线，供电电压为5V。
    - （1）使用频率：24-24.25 GHz。
    - （2）发射功率限值：20 mW（e. i. r. p）。
2. 不得擅自改变使用场景或使用条件、扩大发射频率范围、加大发射功率（包括额外加装射频功率放大器），不得擅自更改发射天线；
3. 不得对其他合法的无线电台（站）产生有害干扰，也不得提出免受有害干扰保护；
4. 本设备能承受辐射射频能量的工业、科学及医疗（ISM）应用设备的干扰或其他合法的无线电台（站）干扰；
5. 如对其他合法的无线电台（站）产生有害干扰时，应立即停止使用，并采取措施消除干扰后方可继续使用；
6. 在航空器内和依据法律法规、国家有关规定、标准划设的射电天文台、气象雷达站、卫星地球站（含测控、测距、接收、导航站）等军民用无线电台（站）、机场等的电磁环境保护区域内使用微功率设备，应当遵守电磁环境保护及相关行业主管部门的规定；
7. 禁止在以机场跑道中心点为圆心、半径5000米的区域内使用各类模型遥控器（本产品不涉及模型遥控器）；
8. 本设备使用环境温度范围为 0℃ 至 40℃。







卡丽官方微信



卡丽新浪官方微博

上海澈和贸易有限公司

地址：上海市静安区江场三路126、128、130号2层

电话：400-920-8262

[www.karat.com.cn](http://www.karat.com.cn)