

卡丽 KARAT[®]

安装使用说明书 INSTALLATION INSTRUCTIONS

美亚一体化智能坐便器, 305mm坑距/400mm坑距
MIYA INTEGRATED TOILET, 305mm/400mm RI
26465T-WK/26466T-WK
26465T-M-WK/26466T-M-WK
24852T-WK/24853T-WK



卡丽官方微信

卡丽新浪官方微博

上海澈和贸易有限公司
地址: 上海市静安区江场三路126、128、130号2层
电话: 400-920-8262

www.karat.com.cn

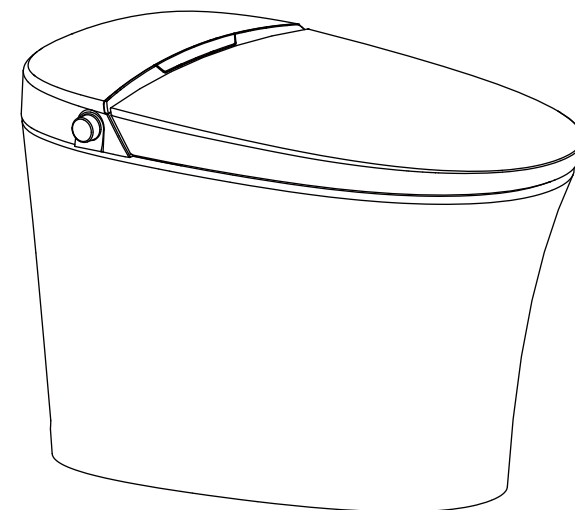

ASVB037810000A-1.4

1534345-T2-E

CONTENTS 目录

安装之前 Before Installation.....	1
产品简介 Introduction.....	2
功能 Function.....	2
安全注意事项 Safety Precautions.....	3
技术参数 Technical Parameters.....	8
尺寸图 Dimensions.....	9
安装尺寸图 Installation Drawing.....	9
整体图说明 Introduction to Overall Diagram.....	9
产品安装 Installation.....	10
确认通水、连接电源 Confirmation of water and Power Connection.....	12
过滤阀芯的保养 Filter Maintenance.....	12
主机旋钮功能说明 Functions of Knob.....	13
遥控器使用 Usage of Remote Control.....	14
安装遥控器 Remote Control Installation.....	19
日常保养 Daily Maintenance.....	21
紧急情况 Emergency Troubleshooting.....	22
注意事项 Precautions.....	24
故障分析和处理 Fault Analysis and Solution.....	24
联系信息 Contact Information.....	25
环保说明 Environmental Friendliness.....	26
能效水效等级说明 Grade of Energy Efficiency and Water Efficiency.....	26
变更记录 Change Record.....	27

卡丽 KARAT[®]

安装使用说明书 INSTALLATION INSTRUCTIONS

BEFORE YOU BEGIN 安装之前

- Please read these instructions carefully to familiarize yourself with the required tools, materials, and installation sequences. Follow the sections that pertain to your particular installation. This will help you avoid costly mistakes. In addition to proper installation, read all operating and safety instructions.
- All information in these instructions is based upon the latest product information available at the time of publication.
- These instructions contain important care, cleaning, and warranty information-**Please leave instructions for the consumer.**
- Obey all electrical regulations in force at the time of installation.
⚠ Warning! Risk of personal injury and product damage. Toilet are very heavy and should not be lifted or installed by just one person.
- 请仔细阅读本指引，以便熟悉所需工具、物料及安装程序。请遵照适用的章节来安装本产品，以免安装失当导致不必要的损失。除了有关正确的安装方法之外，请务必详阅所有操作及安全指引。
- 本指引所載之一切資料，均以印刷時所有之最新產品情況為基礎。
- 本指引也包含了有關保養、清潔及担保等重要資料-**請交予用戶保存。**
- 遵循當地所有的電器安裝規定。
⚠ 警告！小心人身傷害和產品受損。坐便器較重，安裝時請勿一人操作。

SAFETY: WARNINGS

Products are precision engineered and should give continued superior and safe performance, provided:

1. They are installed, commissioned, operated and maintained in accordance with the recommendations given in this Manual.
2. Periodic attention is given, as necessary, to maintain the product in good functional order. Recommended guidelines are given in the **MAINTENANCE** section.

Carefully inspect the new fixture for any signs of damage.

When installing Products, manufacturers guidelines for power tool safety should be followed.

安全：警告

产品经过精确制造，性能卓越，经久耐用。为保证产品品质，您必须：

1. 按照此手册中推荐的方法进行安装、启动、操作及维护。
2. 如有需要，定期检查，令产品保持良好性能状态。日常维护章节中列有推荐方法。

仔细检查新产品是否有损伤。

在安装产品时，必须遵循制造商有关电动工具的安全指令。









TOOLS AND MATERIALS

Pencil
Measuring Tape
Level
Miter Box
Safety Glasses
Drill
Screwdrivers
Hole Saw

工具及材料

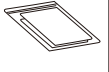
铅笔
卷尺
水平尺
钻子箱
安全眼镜
手枪钻
螺丝刀
孔锯

产品清单

产品	遥控器	安装纸板	密封圈	说明书	进水软管	角阀	7号电池
X1	X1	X1	X1	X1	X1	X1	X1包
							

INSTRUCTION

产品简介

This product has the function of warm water cleaning, DRY, seat ring heating, damping slow down, cleaning intensity adjustment, night light lighting and other functions, and the seat ring temperature, cleaning temperature can be adjusted according to demands.

本产品具有温水清洗、暖风、座圈加热、缓降盖板、清洗强度调节、夜灯照明等功能，座圈温度、清洗温度，可根据需要进行调节。

FUNCTION

功能

Functions 功能项目		MIYA Function Introduction/美亚功能介绍			
		26465T-WK/26466T-WK	24852T-WK/24853T-WK	26465T-M-WK/26466T-M-WK	
Basic functions 基本功能	Rear cleaning/臀洗	●	●	●	
	Front cleaning/妇洗	●	●	●	
	Seat heating/座圈加热	●	●	●	
	Drying/暖风功能	●	●	●	
Well-being functions 舒适功能	Wind temperature adjustment/风温可调	●	●	●	
	Water temperature adjustment/水温可调	●	●	●	
	Seat temperature adjustment/座温可调	●	●	●	
	Instant heated 即热式加热	●	●	●	
	Move cleaning 移动清洗	●	●	●	
	Water volume adjustment 清洗流量可调	●	●	●	
	Spray cleansing location adjustment 清洗位置可调	●	●	●	
	Spray nozzle disassemble 喷嘴可拆卸清洗	●	●	●	
	Nozzle cleaning 喷杆自洁	●	●	●	
	Remote control 遥控操作	●	●	●	
	Quiet soft-closing device 静音缓降	●	●	●	
	Side knob control 侧旋钮控制	●	●	●	
	Mechanical push button flush/无电按钮冲水	●	●	●	
	Intelligent technology 智能科技	Auto function 自动功能	●	●	●
		Seat sensor/着座感应	●	●	●
		Automatic flushing 离座自动冲水	●	●	●

Functions/功能项目		26465T-WK/26466T-WK	24852T-WK/24853T-WK	26465T-M-WK/26466T-M-WK
Intelligent technology 智能科技	Induction night light 光感夜灯	●	●	●
	Diatoms Deodorization 硅藻纯除臭	●	●	●
	User ID setting 用户对码设置	●	●	●
Safety 安全	Antibacterial Seat 抗菌座圈	●	●	●
	Antibacterial Spray nozzle/抗菌喷嘴	●	●	●
	Leakage protection switch/漏电开关	●	●	●
	Automatic pressure discharging/泄压保护	●	●	●
	Heated burning protection/防低温烫伤	●	●	●
	Triple protection 三重保护	●	●	●
Color 颜色	Colors of knobs 旋钮颜色	Silvery/银色	White/白色	Golden/金色
	Colors of decorative bars/装饰条颜色	Silvery/银色	Gray/深灰色	Golden/金色
Rough-in distance (mm) 坑距 (mm)		305/400	305/400	305/400

NOTICE

安全注意事项

In order to avoid injury and property damage to you and others, you must follow the following notes of safety precautions:

Dangers caused by ignoring following warnings or incorrect use fall into two types.



Warning: Violation of Warning precautions may lead to serious injury or death.



Attention: Violation of Note precautions may lead to injury or property damage.

为了避免对您和他人造成伤害和财产损失，请您务必遵守如下有关安全方面的注意事项：

无视如下警示，因错误的使用方法而产生的危害分为两级。



警告：违反警告事项时，可能会造成人的死亡或重伤。



注意：违反注意事项时，可能会造成人的伤害或财产的损失。

WARNING



The product requires 220V~50Hz power. Make sure that the power supply is consistent with the rated voltage and reliable grounding exists within the three-pin socket, so as to avoid electric shock or damage to the product.























Must use 10A electrical outlet. It is recommended to use a water-proof electrical outlet.





















警告



本产品要求电源为220V~50Hz，请确保电源与本机额定电压相符，保证三芯插座内有可靠的接地，以免触电或损坏产品。

必须使用不小于10A插座，最好使用防水插座。

	This product is a fixed appliance and should be installed and fixed in a specific location by professionals.		本产品属于固定式器具，应由专业人士进行安装、固定于特定位置使用。
	The water supply pressure range of this product must be 0.14MPa (flow rate \geq 14.4L/min)-0.8MPa (Hydrostatic pressure) .		本产品供水水压范围必须为0.14MPa(静水压，流量14.4L/min以上)--0.8MPa(静水压)。
	The old aging water supply hose can not be used, otherwise it might cause leakage, fire or electrical shock. Installation of the bidet seat should include specified components and new water supply hose.		安装应使用随器具附带的新软管组件及其它附带或指定的零部件，旧软管组件不能重复利用，否则可能引起漏水、水灾或触电。
	Do not use bad electrical outlet or damaged power plugs, and use and protect the power cord properly, so as to avoid risks of electric shock or fire due to bad contact or damage.		请勿使用不良的电源插座及破损的电源插头，请正确使用并保护好电源线，以免接触不良，破损等导致触电或引发火灾等危险。
	If the power cord is damaged, it must be changed by specialist of the manufacturer, its maintenance department or other similar departments, or electric shock or fire may occur.		※如果电源线损坏，为了避免危险，必须由制造商、其维修部或类似部门的专业人员更换，否则容易引起触电、火灾。
	This product must be grounded securely. Make sure to provide grounding protection for the AC socket, and use the three-pin socket for the grounding wire. If you are not sure if it is grounded securely, ask a qualified electrician or service person to check and verify the condition. Please make sure the wiring of the power ocket used for this product is in compliance with the national standard (null line on the left and live line on the right) and should not be reversed.		本产品必须可靠接地，且需确保交流插座地线对大地的可靠连接，接地线应使用三脚插座。如果不确定是否已可靠接地，请让一位合格的电工或维修人员检查确认。请确保产品使用的电源插座接线符合国家标准（左零右火），不能接反。
	A power circuit breaker should be connected in series with the power supply circuit in the same room; Otherwise there may be a risk of personal injury or property damage.		安装本产品时，应在安装产品同一房间的电源进线回路中串联一个能使本产品电源全级断开的分断装置方可安全使用；否则本产品的意外故障可能会导致生命危险或财产损失。
	Do not disassemble, repair or modify the product by yourself and should not change internal wiring, components and protective devices., so as to avoid electric shock, fire, electric leakage or other faults.		严禁自行拆卸，修理或改造产品，不应变更内部接线、部件和保护装置。以免造成触电，火灾，漏电或其他故障。
	When unplugging the power plug from the socket, hold the plug body and do not apply tension to the power cord.		从插座上拔下电源插头时，须手持插头本体，不对电源线施加拉力。
	If the product produces abnormal noise, abnormal odor, abnormal temperature or malfunction, please stop using it immediately, unplug the power plug, close the water supply valve, and contact the service provider in time.		产品出现异常噪声、异常气味、异常高温或故障时，请立即停止使用，关闭开关，断开电源，同时关闭供水阀门，并及时与客服联系。
	The drainage pipe connected to this product must be connected to the sewage system.		本产品所连接的排水管必须连接到污水系统。
	Do not throw cigarettes and other burning stuff into toilet, otherwise it might cause fire.		点燃的香烟及其它燃烧物不能投入坐便盖内，否则可能会引起火灾。

	WARNING: There is risk of electric shock. This product must be grounded safely, can only connect to exclusive 220V~, 50Hz, 10A circuit which protected by Ground-Fault Circuit-Interrupters (GFCI's) or Earth-Leakage protector.		警告： 产品存在电击的危险。本产品必须可靠接地，只能连接到专用的220V~、50Hz、10A带接地故障断路器或接地漏电保护器的电路中。
	Do not use plugs with loose power outlet, do not put the body of the product and plugs in the water or shower them with water, and do not use the product under excessively humid condition, so as to avoid electric shock or fire. When power failure occurs, immediately unplug the power cord and contact maintenance staff.		请勿使用插头配合松动的电源插座，请勿将本体和插头放在水里或淋水，请勿在过于潮湿的环境下使用，以免造成触电或火灾。电源出现故障时请立即拔下电源插头并联系维修人员。
	Children, elders or those with disabilities from their body, sensitivity or mental disabilities or lacking of common sense should not use or get close to this product unless under close tutelage. Children are not allowed to use or touch this product. Do not leave children alone in a room with such product. For those children and the elderly who are unable to adjust the temperature, they should ask for help to adjust seat temp, flush temp and wind temp of bidet seat to the proper gears. Exposed skin should not make contact with the heated seat for too long a time to prevent low temperature burning.		当儿童、老年人、残疾人、以及身体、感知、智力能力缺陷或经验和常识缺乏的人使用或靠近此产品时，近距离的监护是必需的。儿童不应该被允许使用或接触此产品，不要让儿童独自待在安装有此产品的房间，儿童不应玩耍器具。对于无法自己进行温度调节操作的儿童和老人，需要帮助将便盖的圈温、冲水温度及风温调节到合适的档位。请避免长时间让裸露的皮肤接触加热座圈，以免低温灼伤。
	When the product moves from cold or wet environment into normal room temperature, wait for 2 hours until the condensation water is fully volatilized. Doing so can prevent the product from electrical short-circuit.		当产品由寒冷或潮湿的地方搬至室内时，先放置2小时，使机内凝水充分挥发，再开机使用，以免造成产品短路。
	Do not handle the electrical plug with wet hands. Doing so may cause electrical shock.		严禁用湿手触摸电源插头，否则可能会引起触电。
	It is prohibited to use other electric appliances in the same socket.		严禁在同一插座上使用其他电器。
	It is forbidden to use the power extension or unstable loose outlet, otherwise it may cause fire or electrical shock.		严禁使用电源延长线或松脱不稳的电源插座，否则可能会引起火灾或触电。
	Do not put hand or other staff over the outlet of air dryer or block the outlet of air dryer. Doing so may cause burn and electrical shock.		请勿用手指或其他物品放入或者堵塞暖风出口，否则可能会引起烫伤、触电或烧毁。
	Do not lay on side or upside the product during the electrical circuit, to avoid fire or burning.		产品通电时，不得将产品侧放或倒置，否则可能会引起火灾或烧毁。
	Prohibit stepping on the body and cover of the machine and prohibit putting heaters or heavy objects on the unit and cover, power cord of the machine, so as to avoid electric shock or other injuries and damage.		严禁踩踏机器本体和便盖，严禁把加热器或重物放在机器本体、便盖、电源线上，以免造成触电或其他伤害和损坏。

- | | |
|--|---|
|  Users should not replace fuses in household appliances and power supplies with ordinary conductors or fuses with current capacity exceeding the specified value. |  使用者不应以普通导体或超出规定电流容量的熔断体替换家用电器和电源的熔断体。 |
|  Users should not change the setting values of low voltage circuit breakers or residual current operated protectors on their own. |  使用者不应自行改变低压断路器或剩余电流动作保护器的设定值。 |
|  In the same room where the product is installed, it is necessary to install a water stop valve at the accessible position. In case of emergency, the water inlet can be cut off without using any tools. Otherwise, the unexpected failure may lead to the loss of users. |  在安装本产品的同一房间中，需要在触手可及的位置安装一个止水阀，用于紧急情况下，无需借助工具即可切断本产品的进水路；否则本产品的意外故障可能导致用户损失。 |
|  For models with foam shield function, do not run the foam shield function without foam agent; otherwise, the service life of the foam shield may be shortened. |  若带有泡沫盾功能的机型，请勿在未装有“泡沫剂”的情况下运行泡沫盾功能，否则可能缩短泡沫盾使用寿命。 |
|  Please unplug the power cord when it thunders. When out of service for a long time, please cut off water and the circuit and drain water within the product. Do not put the body of the product near heaters or fireplace, which may deform and discolor it. Please prevent the sun from shining directly on the product, which may discolor the product. |  在打雷时请将电源线插头拔掉。长期不用时，请将水电路切断，并将产品内部积水排净。请不要把取暖器或壁炉等产品靠近本体，否则会导致本体变形，变色。防止日光直接照射，否则会引起产品变色。 |
|  Make sure that the water supply is clean tap water. Do not use contaminated or industrial water. |  请确保使用的水源是干净的自来水，不可使用污染的水源或工业用水。 |
|  Do not urinate on the nozzle of the cleaner to prevent filth blocking, and do not urinate into the outlet of heater wind to avoid corrosion and electric leakage. |  请勿将小便淋于清洗器的喷嘴以免产生污垢导致堵塞，或将小便射进暖风出口位置，以免产生腐蚀而导致漏电。 |
|  Do not use the product in the places close to bathtub or water tank. Do not touch the product that has fallen into liquids, immediately pull out the power plug. |  请勿将产品放置在可能掉入或被拉入浴缸或水槽的位置。请勿触及已经掉入水中或浸水的产品，并立刻拔掉电源插头。 |
|  Do not reverse the product to use, which damages the product. |  请勿将产品翻转使用，否则会损坏产品。 |
|  Please don't plunge into toilet bowls with easily blocked items such as newsprint, paper diapers, and sanitary napkins. |  请不要向便器内冲入新闻纸、纸尿裤、妇用卫生中等容易堵塞的物品。 |
|  Please do not use gravity to impact the ceramic to prevent damage. |  请不要用重力撞击陶瓷，以防止破损漏水。 |

- | | |
|--|--|
|  Please do not embed cementations materials (cement mortar, etc.) on toilet seats to prevent them from swelling due to swelling. |  请不要在便器底座埋入胶凝材料（水泥砂浆等），以防止因膨胀而撑裂便器。 |
|  Do not strike the product. |  请勿撞击产品。 |
|  Do not use lacquer thinner, petrol, liquid medicine, detergent, insecticide, toilet cleanser and scrubbing brush to clean the product. |  禁止使用香蕉水、汽油、药水及洗涤剂、杀虫剂、厕所清洁剂和硬毛刷清洁本产品。 |
|  This product is equipped with a soft-closing seat cover. Do not push the toilet seat closed, or damage may occur. |  本产品座圈有缓降功能，请勿用力按压，以免损坏缓降器。 |
|  Do not lean against the seat cover when using the product, to avoid damage. |  使用产品时，请勿向后靠在便盖上，以免损坏产品。 |
|  Do not twist and break the water inlet pipe. |  请勿将进水管扭曲破断。 |
|  In winter, when the product is transported over a long distance or kept for a long time, the remaining water in the product may freeze. To prevent damage caused by freezing, please adopt measures to fight against freezing. |  在寒冷的冬季，当产品在经过长途运输或长时间存放时，产品内剩下的积水可能会发生冻结现象。为预防冻结造成损坏，请采取防冻措施。 |
|  Please do not use in environments below 1°C. |  请不要在1°C以下环境中使用。 |
|  When installing, disassembling, repairing, and maintaining the product, you must unplug the power supply and close the water supply valve. |  进行安装、拆卸、维修及保养产品时，必须拔下电源插头，关闭供水阀门。 |
|  CAUTION:
There is risk of hazardous gases. If a new toilet is not installed immediately, a piece of rag can be temporarily covered over the ground outfall. |  谨慎：
存在有害气体危险。如果新坐便器不能立即安装，可在地面排污口上临时遮盖一块旧布。 |
|  NOTICE:
Receptacles installed in bathroom to be located at least 1 meter from a bathtub or shower if practical. Observe all local plumbing and building codes. Carefully inspect the new toilet for damage. |  注意：
安装在浴室内的插座位置距离浴缸或淋浴喷头至少应为一米。遵守所有的本地管道安装规范和建筑规范。仔细检查新坐便器有无损坏。 |

SPECIFICATIONS

技术参数

Rated pressure	220V~, 50Hz
Rated power	1070W (As for the test condition and standard, please refer to the upper part on page 9.)
Overall unit Waterproof	IPX4
Water pressure range	0.14MPa (flow rate \geq 14.4L/min) ~0.8MPa (Hydrostatic pressure)
Maximum cleansing flow	560ml/min
Electrical wire	length is about 1.2m
Flush volume(L)	4.6L(Full Flush 5.8L/Half Flush 4.0L)
Flushing mode	Siphonic jet
Outlet outside diameter	\leq 100mm
Drainage method	Down-drain
Deodorization Method	Diatoms Deodorization
Washing settings	
Heating power	1600W
Water temperature	6 different level adjustment
Water volume	3 different level adjustment
Cleansing mode	Rear washing/Move washing, Feminine washing/ Move washing
Spray cleansing location	5 different level adjustment
Water pressure protector	Pressure stabilizer, Automatic pressure discharging
Anti-fouling device	Automatic cleansing nozzle, Anti-syphon device, Anti-backflow device, Filter device
Safety device	Thermal fuse, Water temperature sensor, Ground protection, Thermostat, Over temperature protection, Leakage protection plug
Heater Wind Device	
Warm wind speed	Over 0.2m ³ /min
Warm wind temperature	6 different level adjustment
Heating power	250W
Safety device	Thermal fuse, Temperature sensor, Thermostat
Seat Heating Device	
Surface temperature	6 different level adjustment
Heating power	50W
Heated burning protection	The seat temperature will automatically lower to level 1 in 10 minutes after using
Safety device	Sensed area, Temperature sensor, Thermal fuse, Bimetal thermostat, Leakage protection plug
Others	
Night light assembly	Intelligent, often in the off state
User ID setting	To avoid disturbance from remote controls by multi-user

额定电压	220V~, 50Hz
额定功率	1070W (具体测试条件及参数请参考第九页上半段)
整机防水	IPX4
水压范围	0.14MPa (静水压, 流量14.4L/min 以上) ~0.8MPa (静水压)
最大清洗流量	560ml/min
电源线	长度约1.2米
平均用水量 (L)	4.6L (大冲5.8L/小冲4.0L)
冲洗方式	喷射虹吸式
排污口外径	\leq 100mm
排水方式	下排水
除臭方式	硅藻纯除臭
清洗装置	
加热功率	1600W
温水温度	6档调节
清洗流量	3档调节
清洗方式	臀洗/移动清洗, 妇洗/移动清洗
喷洗位置	5档调节
水压保护	稳压装置、自动泄压装置
防污装置	喷嘴自动清洗装置、防虹吸装置、防倒流装置、过滤装置
安全装置	温度保险丝、水温传感器、接地保护、双金属片温控器、漏电自动断开、过温断水保护、漏电保护插头
暖风装置	
暖风风量	大于0.2立方米/分钟
暖风风温	6档调节
加热功率	250W
安全装置	温度保险丝、温控器、漏电保护插头
暖座装置	
表面温度	6档调节
加热功率	50W
防低温烫伤	使用10分钟后, 座温自动缓慢降低到低档
安全装置	着座感应器、温度传感器、温度保险丝、温控器、漏电保护插头
其他	
夜灯设置	智能、常灭
用户码设定	防止多台产品多个用户使用, 互相干扰

Automatic flushing	Toilet will automatically flush as user walks away from bowl
Open and close device	Quiet soft-closing device
Power off flush	Toilet will washed manually after power failure

自动冲水功能	可实现便后自动冲刷功能
缓降盖板	关闭座盖时缓降关闭
断电冲水功能	可实现断电后手动冲刷马桶功能

额定功率: 本产品环境温度23℃, 进水动压0.18MPa \pm 0.02MPa, 进水温度约15℃条件下, 开始上电开机, 依次将水压、座温、水温设置为最高档后, 立即开启臀洗并持续稳定工作一个清洗周期的平均功率。
本产品符合GB/T 23131-2019标准中的清洁率要求。本产品最佳清洁率测试方法: 将喷杆位置调至最前端, 水压档位调至最大档, 同时开启移动清洗功能。

ROUGHING

尺寸图

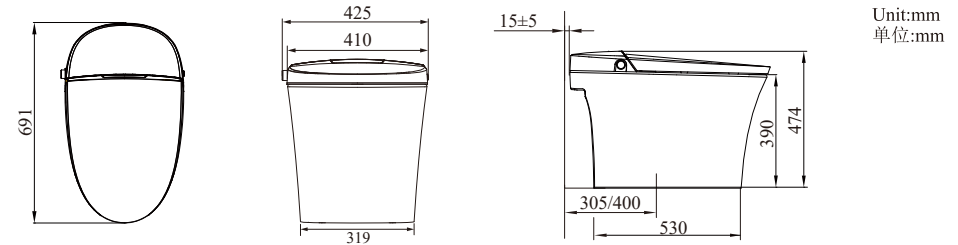

*The size is for reference only, please check the actual size before installation.

*此尺寸仅供参考, 安装前请仔细测量实际产品。

INSTALLATION DRAWING

安装尺寸图

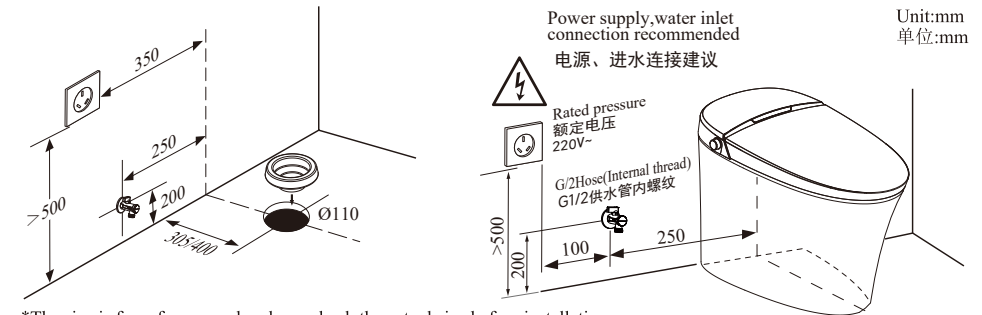

*The size is for reference only, please check the actual size before installation.

*此尺寸仅供参考, 安装前请仔细测量实际产品。

SKETCH

整体图说明

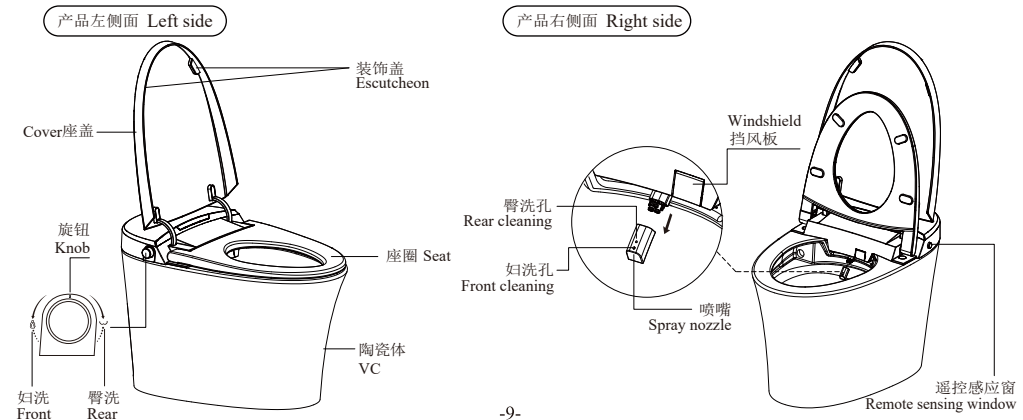

⚠ Precaution before installing

Lowest static water pressure:
Pipe flowing volume $\geq 0.14\text{MPa}$ (flow rate $\geq 14.4\text{L/min}$),
it will not achieve best flushing performance in case above
condition not fulfill.

Remark: Apply the methods below if you don't have
water pressure testing device.

Angle valve type	Water volume 10s
Mating angle valve	More than 2.4L

Reaching appointed water volume represents it meets
water pressure requirement.



1. Installation of mating angle valve

Draw drain outlet centerline on the floor, Install angle
valve at proper position on wall according to dimension
of toilet.

(Please use the angle valve and hose coming with the
product and do not use the old pipe, which may lead to
risk of water leakage.)

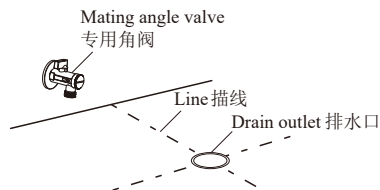

2. Cardboard installation

- Align cardboard with the centerline of drain outlet;
- Draw contour line according to cardboard;

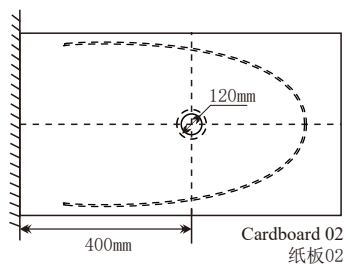
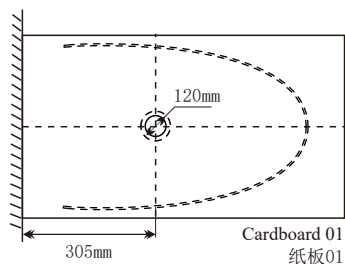

⚠ 安装前注意事项:

- 最低静态工作水压: 0.14MPa 以上管道过水量 (14.4L/min 以上), 未能满足此压力将无法达到最佳冲刷效果。

注: 若无水压测试装置, 可参照下述方式。

角阀类型	水量 (10秒)
配套角阀	2.4L 以上

达到表述水量, 则可确保产品最低水压

1. 安装配套专用角阀

在地面标出排水口的中心线, 按坐便器的尺寸, 在墙面的合适位置安装进水角阀。

(必须使用产品自带的新角阀和新软管组件, 不要使用旧管组件, 否则会引起漏水风险)

2. 安装纸板安装说明

- 将安装纸板对齐排污口中心线;
- 根据安装纸板描绘出相应的轮廓线。

3. Installation of angle valve and flexible hose

- 安装角阀。
- Installation of angle valve

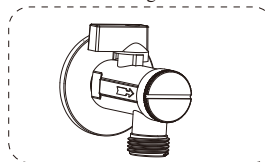

- Connect water inlet and angle valve with new hose
- 用新软管将坐便器的进水口和角阀连接起来。

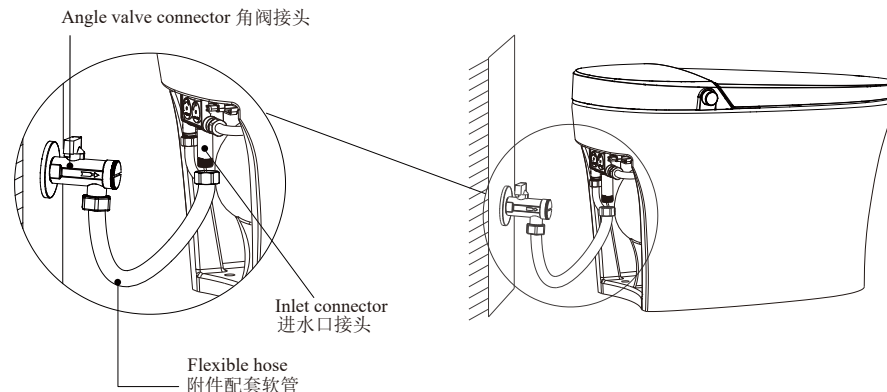

4. Ceramic toilet installation

- Install sealing flange into drain outlet;
- Install ceramic toilet on corresponding position according to contour line.

5. Apply high quality mildew glass glue around the lower edge of the toilet.

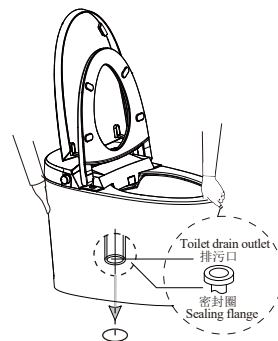

3. 安装角阀和软管

4. 安装坐便器

- 将密封圈套入坐便器排污口;
- 根据描绘出的轮廓线将坐便器装入相应位置。

5. 涂玻璃胶

在便器下边缘周围涂上优质防霉玻璃胶。

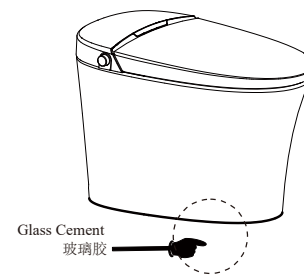

Tips: The toilet is heavy, and it needs to open the seat cover to carry it by two people.

温馨提示: 由于一体机比较重, 需翻开座圈, 由两人配合抬起。

Tips: Please clean the drain outlet; Please make sure ceramic toilet outlet sits perfectly on drain outlet.

温馨提示: 请将排污口的垃圾和其他污物清理干净; 安装便器时, 请确保坐便器排水口与地面排污口安装到位。

OVERALL SKETCH

- Turn on the angle valve
Check thread connection, make sure no leakage is found, unscrew angle valve anticlockwise to maximum opening.
- Switch the power supply
Insert electric leakage protection plug into power socket, protection switch, indicator light is on which means there is electricity. Press electric leakage test button prior to usage, protection switch bounces to show that protection function works normally.
- Self-inspection
※ Unscrew angle valve anticlockwise to make the buzzer;
※ rings second "click", red light self-inspection is finished;
※ Start function mode for normal usage.

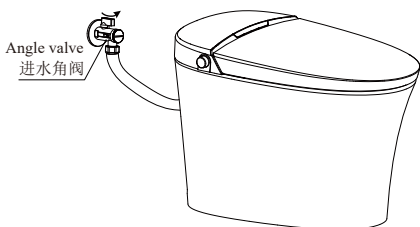

Tips: Press electric leakage test button prior to usage, protection switch protection function works normally.

确认通水, 连接电源

- 打开角阀
查看螺纹连接处密封性, 确定不漏水, 逆时针旋开角阀, 开口调至最大。
- 接通电源
电源线漏电保护插头插入电源插座, 按下复位开关, 插头指示灯亮, 表示通电。
- 安全自检
1. 主机蜂鸣器一声“嘀”, 旋钮亮蓝灯, 开始自检;
2. 主机蜂鸣器再响一声“嘀”, 自检完毕, 旋钮亮红灯;
3. 功能模式开启, 正常使用。

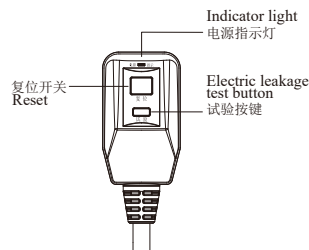

温馨提示: 使用前先按下试验按键, 复位开关弹起, 指示灯熄灭, 表示漏电保护功能正常。

MAINTENANCE OF FILTER NET

Time for maintenance: It is under normal water pressure but poor flush occurs.

- Cut off the power and close the angle valve.
 - Unscrew angle valve nut.
 - Remove filter net.
 - Use the brush to clean filter net.
 - Reinstall filter net and angle valve nut.
 - Open the angle valve, connect the power supply, and use it normally after self inspection.
- *It is recommended that you clean the filter once in 1-2 months

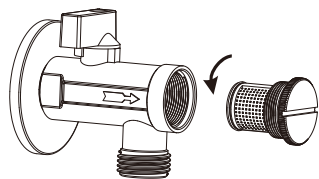

过滤阀芯的保养

保养时机: 当水压正常但冲刷效果不佳时。

- 切断电源, 关闭角阀
 - 旋开角阀螺母
 - 取出过滤阀芯
 - 用牙刷刷洗, 清水冲去阀芯内泥沙
 - 装回过滤阀芯, 重新安装角阀螺母
 - 打开角阀, 接通电源, 自检完毕后即可正常使用
- *建议1-2月清洗一次过滤网

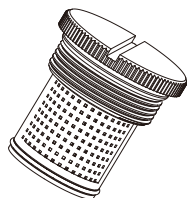

FUNCTIONS OF KNOB

主机旋钮功能说明

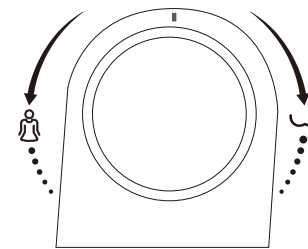



Instruction of knob:

[ON/OFF] Long pressing switch knob more than 3 sec.

[FLUSHING] Switch on → Lightly pressing switch knob → Flushing

[REAR CLEANING] Switch on → Sit on seat → Rotate switching knob clockwise  to start rear cleaning → Lightly pressing the knob to stop this action or after 150 sec automatically start drying function → Flush when user gets off the seat.

[FEMININE CLEANING] Switch on → Sit on seat → Rotate switching knob anti-clockwise  to start feminine cleaning → Lightly pressing the knob to stop this action or after 150 sec automatically start warm wind blowing function → Flush when user gets off the seat.

[NOZZLE CLEANING] Switch on, on standby mode, rotate switching knob clockwise , nozzle extends out → Hand cleaning → Rotate switching knob clockwise  again or lightly pressing the knob, nozzle retracts and stop cleaning.

Remark:

- Red light flashes around switch button to indicate functional mode, blue light flashes around switch button to indicate energy-saving mode, purple light flashes around switch button to indicate flushing mode, no light flashes to indicate standby mode.
- The default setting of all function is on middle level, after using controller, shift to the level setted last time.
- Under rear / feminic cleaning mode, the nozzle position and water pressure is adjustable by rotating the switch knob. Long pressing knob swithcs the function inbetween water pressure and nozzle position function.
- Under drying mode, stop the blowing by lightly press the knob.
- Switching knob can only perform flushing function (manual) when power is off.



旋钮操作说明:

[开/关机] 长按旋钮3秒以上

[冲水] 开机→轻按旋钮→冲水

[臀洗] 开机→着坐→顺时针旋钮, 开启臀洗→轻按旋钮, 结束臀洗或约150秒后自动进入暖风功能→离座冲洗

[妇洗] 开机→着坐→逆时针旋钮, 开启妇洗→轻按旋钮, 结束妇洗或约150秒后自动进入暖风功能→离座冲洗

[清洗喷嘴] 开机, 无使用状态下, 顺时针旋钮, 喷杆伸出→手动清洗→再顺时针旋钮或轻按旋钮, 喷杆缩回, 结束清洗。

温馨提示:

- 机器处于开机状态时, 旋钮指示灯亮红灯; 处于开机且节能状态时, 旋钮指示灯亮蓝灯; 处于坐便器冲水状态时, 旋钮指示灯亮紫灯; 处于关机状态时, 旋钮指示灯灭。
- 刚开机, 所有功能档位及喷杆位置设置在中间档, 当使用遥控器后, 切换到遥控器显示的功能档位。
- 在臀、妇洗状态下, 通过前后旋转旋钮可调节喷嘴位置和水压大小, 长按旋钮可在水压调节和喷杆位置调节功能间切换。
- 在暖风状态下, 轻按旋钮可停止暖风。
- 断电情况下, 旋钮仅冲刷功能可以使用。(无电冲刷功能)

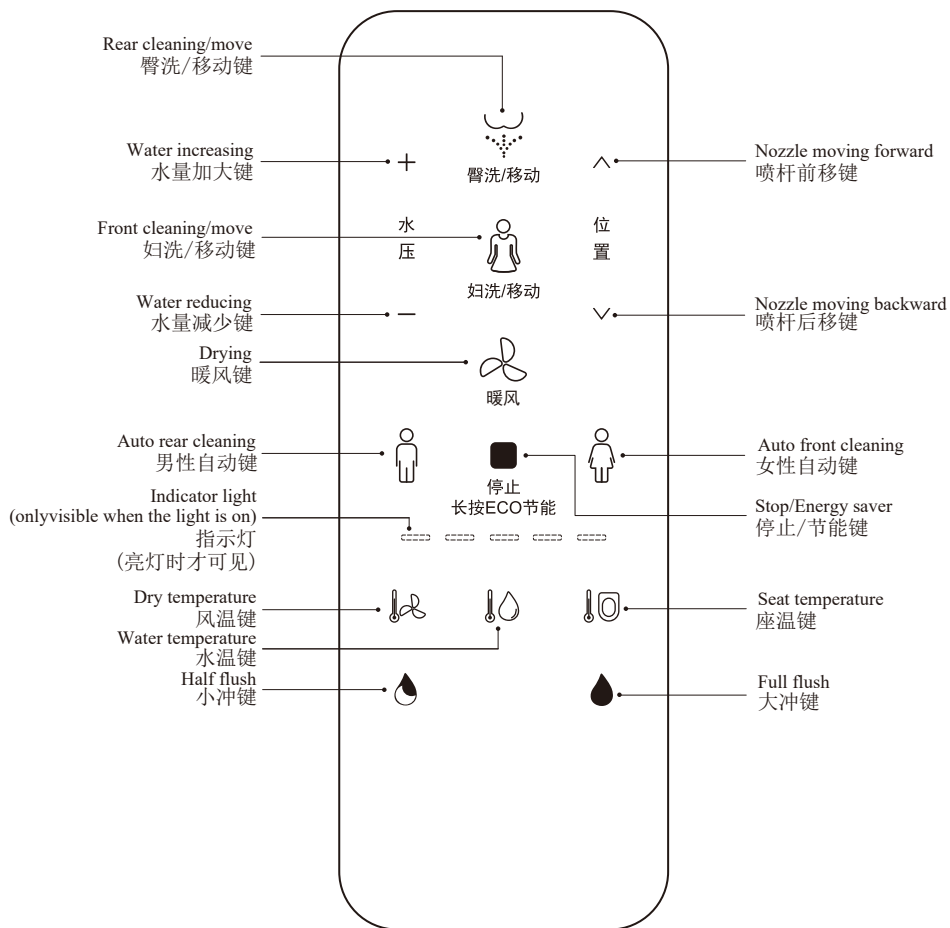

Rear/Front cleaning

Press "REAR/MOVE" button, the indicator light is on showing current water temperature level, it starts spraying to clean the buttocks; it will stop drying automatically after a circle of 150 seconds; If you press the "STOP" button midway, you can stop cleaning immediately.

Press "FRONT/MOVE" button, the indicator light is on showing current water temperature level, it starts spraying to clean the front; it will stop drying automatically after a circle of 150 seconds; If you press the "STOP" button midway, you can stop cleaning immediately.

Drying Operation

Press "DRY" button, warm wind comes out of wand to dry. After a cycle of 5 minutes or user leaves the seat, it automatically stops.

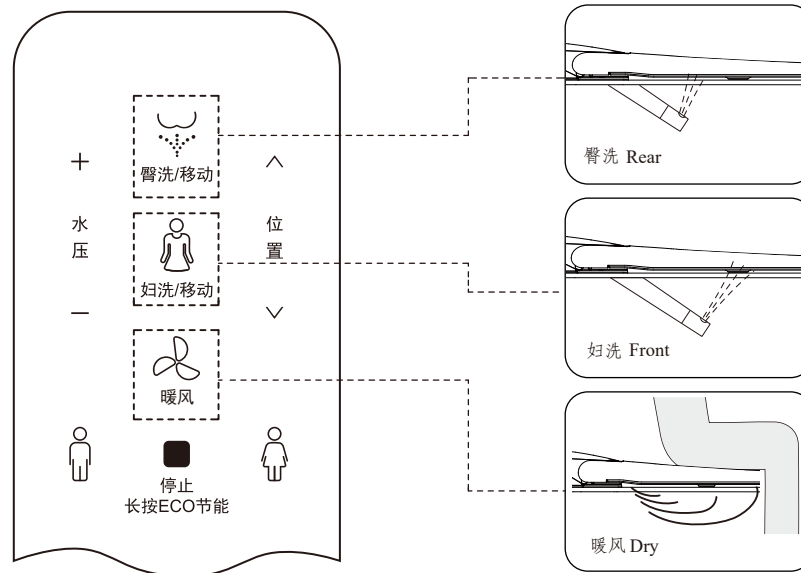

臀洗/妇洗操作

按一下“臀洗/移动”键，指示灯亮起，显示当前水温档位，喷水清洗臀部，再按一下则切换到移动清洗（喷嘴前后移动，扩大洗净范围），持续清洗一个周期约150秒后自动停止，若中途按下“停止”键，可立即停止清洗。

按一下“妇洗/移动”键，指示灯亮起，显示当前水温档位，喷水清洗阴道，再按一下则切换到移动清洗（喷嘴前后移动，扩大洗净范围），持续清洗一个周期约150秒后自动停止，若中途按下“停止”键，可立即停止清洗。

暖风操作

按“暖风”键，暖风吹出，开始暖风功能，一个周期约5分钟后或人体离开座圈后，自动停止暖风。

Spray nozzle position adjustment

Presss "∧" or "∨" button when it is under function of rear cleaning or front cleaning, the indicator light will be on showing current nozzle position, adjust nozzle position by 5 levels.

喷嘴位置调节

在“臀洗”或“妇洗”时，按喷嘴位置“∧”、“∨”键，指示灯亮起，显示当前喷嘴档位，可在5档之间调节喷嘴位置前移、后移。

Water volume adjustment

Presss "+" or "-" button when it is under function of rear cleaning or front cleaning, the indicator light will be on showing current water temperature level, adjust water volume by 3 levels.

水压调节

在“臀洗”或“妇洗”时，按水压“+”、“-”键，指示灯亮起，显示当前水压档位，可调节3档水压大小。

Full Flush /Half Flush

Press the "FULL" button to activate full flushing;
Press the "HALF" button to activate half flushing;

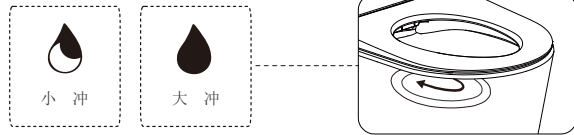

大冲/小冲冲水

• 按下大冲按键/小冲按键，坐便器开始大冲/小冲冲水。

Dry temperature adjustment:

Wind temperature adjustment: Press the "风" button, the indicator light will light up the displayed wind temperature level position, continue to press the "风" button to adjust the air temperature. It will be neutral level when the indicator light is off, and the level position adjustment mode is up and down cycle.



风温调节:

按“风”键，指示灯亮起显示的风温档位，继续按“风”键调节风温，指示灯不亮时为空档，档位调节方式为上下循环。

Water temperature adjustment: Press the "水" button, the indicator light will light up the displayed water temperature position, continue to press the "水" button to adjust the water temperature, and the indicator light will be neutral when the indicator light is off (Note: the setting temperature is 10±2.5°C when the neutral level is in progress. When the water temperature is higher than 10°C, it will not be heated; when it is lower than 10°C, it will be heated; and the temperature of the outlet water will be controlled at about 10°C). And the level position adjustment mode is up and down cycle.



水温调节:

按“水”键，指示灯亮起显示的水温档位，继续按“水”键调节水温，指示灯不亮时为空档（注：空档时设定温度为10±2.5°C，即当进水温度高于10°C时不加热，低于10°C时加热，控制出水温度在10°C左右），档位调节方式为上下循环。

Seat temperature adjustment: Press the "座" button, the indicator light will light up the displayed seat temperature position, continue to press the "座" button to adjust the seat temperature, the indicator light will be neutral when the indicator light is off. And the level position adjustment mode is up and down cycle.



座温调节:

按“座”键，指示灯亮起显示的座温档位，继续按“座”键调节座温，指示灯不亮时为空档，档位调节方式为上下循环。

Auto function

The automatic function of factory default setting is middle level for water volume, nozzle position, water temperature, air temperature, seat temperature; is turned off for massage function. Users can set their personal favorite 6 state values such as level position and temperature and so on.

Short press "男" or "女" to start rear cleaning or front cleaning automatically. The user can first set the water volume, nozzle position, temperature level and whether to open the massage function. After the setting is completed, press and hold the corresponding automatic button 3S to save the setting. The next time you use it, you can call the saved settings to turn on the automatic function by pressing the corresponding auto button, to achieve automatic cleaning, drying, etc.

The Auto function mode will be off if the user presses other buttons during operation of auto functions and shift to operate the functions of the buttons.

自动功能

- 自动功能出厂默认水量、喷嘴位置、水温、风温、座温均为中档。
- 短按遥控器上“男”、“女”可分别实现男性臀洗和女性妇洗全自动便捷使用。用户可先设定适合自己的水量大小、喷嘴位置、水温档位、风温档位，设置完成后长按对应自动键3秒保存设置，下次使用时只需按对应自动键即能调用保存的设置开启自动功能，实现全程免操作自动清洗、暖风功能等。
- 自动功能运行期间若按其他功能键，则会中断退出自动模式，执行所按功能键功能。

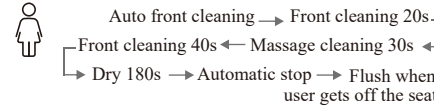
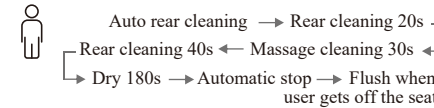

Energy saver

Press and hold the "Stop" button for more than 3 seconds to enter the power save mode, at this time the main unit knob indicator changes from red to blue light. Press and hold again "Stop" button for more than 3 seconds to exit the power save mode, at this time the main unit knob indicator changes from blue to red light.

Energy saving:

Under energy saving mode, seat temperature is low (level 1) to achieve energy saving. (Note: If the seat temperature before energy saving is neutral, keep the neutral after energy saving)

Remark:

Energy saving mode will be suspended and goes to function mode if someone user the seat in the middle of energy saving. The seat starts to heat immediately (without closing the seat temperature), and the energy saving mode is restored after the human body leaves the seat.

Combination button

Night light

Night light factory default setting to be intelligent mode (automatically turn on/off the night light according to the external environment), first press and hold the "STOP" button, then press the "Dry" button to exit the smart mode. The night light is often off. Repeat the above actions to turn on smart mode.

Quiet mode

Press "STOP" button and then "蜂" button to turn off buzzer to avoid noise in the night; Repeat the process to start buzzer function.

User code

The user code needs to be set to avoid disturbance from remote controls when more than one toilets are used in the house. Turn on the toilet for setting while turn off others.

- Press User code buttons (Press "STOP" button first and then press "REAR" button) to enter into user code setting mode, the indicator lights will be on and keep flashing
- Press the water volume "+", "-", "-" button to choose user code, adjust the user code 1~9, the indicator light shows the corresponding user code.

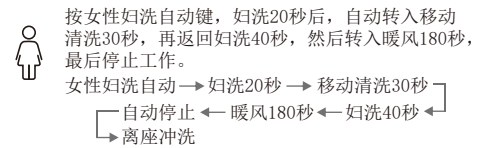
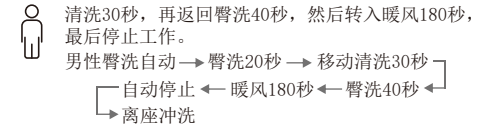

节能设置

长按“停止”键3秒以上，进入节能模式，此时主机旋钮指示灯由红色变为蓝色。再次长按“停止”键3秒以上，退出节能模式，此时主机旋钮指示灯由亮蓝灯变为亮红灯。

节能:

设定节能后，在节能模式下，座温处于低温状态（第一档温度）以达到节能的目的。（注：节能前座温若为空档，节能后保持空档）

提示:

节能时如果中途有人使用座圈，节能模式暂停，进入功能模式，座圈立即开始加热（不关闭座温情况下），人体离开座圈后，即恢复节能模式。

组合按键

夜灯按键

夜灯出厂默认设置为智能模式（依外界环境明/暗自动开/关夜灯），先按住“停止”键，再按“暖风”键，退出智能模式，夜灯常灭。重复以上动作，开启智能模式。

静音按键

夜间使用为防止蜂鸣器影响休息，先按住“停止”键，再按“蜂”键，关闭蜂鸣器，进入静音模式。重复以上动作，开启蜂鸣器。

用户按键

用户使用多台产品时需设定用户码，防止遥控器互相干扰；需要设定的主机通电开机，其他主机关闭电源。

- 按下用户码按键（先按住“停止”键，再按“臀洗”键）进入用户码设定模式，指示灯亮起并闪烁。
- 按水量“+”、“-”键来选择用户码，调整用户码1~9，指示灯显示对应应用户码。

- Press "STOP" button and then "REAR" button again, remote control will save the setting and exit user code setting window, the buzzer will ring "click" to indicate successful setting.

- If the main unit is powered off and then restarted or the battery is removed from the remote control, press any key to release the capacitor on the keypad, the user code will be cleared and needs to be reset.

- Remote control will exit user code setting mode and go back to previous mode if there is no action for 10S after enter into user code setting mode.

Automatic flush button

Press "STOP" button and then "FLUSH" button to start or close automatic flushing function. When the automatic flushing function is turned on, toilet will automatically flush after detecting user sitting for more than 6 seconds and leaving the seat for more than 3.5 seconds. When the user is sitting for more than 6 seconds and less than 60 seconds, half flushing is turned on after the user leaving the seat. When the user is sitting for more than 60 seconds, full flushing is turned on after the user leaving the seat.

Auto deodorizing button

Press "STOP" button first and meanwhile press "FRONT" button to start or close auto deodorizing function; The deodorizing function will be activated when detect the user sitting on the seat, the function will stop 3S after the user leaves. The deodorizing function will be off during drying operation.

Remark:

- The buzzer will sound "beep" when the user presses one button which means the main unit receives the signal and conduct the operation accordingly. If the buzzer doesn't sound, it means the main unit doesn't receive the signal, please adjust the remote control direction and repress the button.

- In case of power cut during wand's spray operation, the wand cannot go back to place, please wait until the power is reset. In case of a power cut for a long period, please push the wand softly back by hand. Do not push hard, to avoid damage to wand and electrical machine.

- The body should touch the seat and the buzzer rings "click", which means functions of front cleaning, rear cleaning and drying are in operation. The nozzle will continue to spray for 1~2 seconds after user stands up during spray operation, so please press "STOP" button before standing up.

- 再按一次用户码按键，遥控器保存设置并退出用户码设定界面，蜂鸣器响一声“嘀”，设定成功。

- 如果主机断电后重新开机或者遥控器拆下电池，并按任意键释放掉按键板上电容电量后，则用户码会清零，需重新设置。

- 进入用户码设定模式后，如果连续10秒无任何操作，遥控器将自动退出用户码设定模式，返回未进入用户码设定模式前的状态。

自动冲水键

先按住“停止”按键，并按下“大冲”按键，开启或关闭自动冲水功能；在开启自动冲水功能后，当检测到用户着座6秒以上且离开座圈3.5秒以上，则执行自动冲水功能。其中：当用户着座时间6秒以上60秒以内时，离座为小冲水，当用户着座时间超过60秒时，离座为大冲水。

自动除臭键

先按住“停止”按键，并按下“妇洗”按键，开启或关闭自动除臭功能；在开启自动除臭功能后，当检测到用户着座时开启除臭功能，离座3秒后停止。暖风时，除臭功能关闭。

温馨提示:

- 每次按按键，蜂鸣器“嘀”响一声，表示主机接收到信号，并执行信号。如果蜂鸣器未响，表示主机未接收到信号，请调整遥控器发射方向重新按按键。

- 在喷洗过程中，突然停电，喷杆无法缩回，请等待来电重新开机，喷杆会自动收回。若长时间断电且需要使用马桶，可轻轻用手将喷杆推回。请勿用力推拉喷杆，以免损坏喷杆和电机。

- 人体必须着座，蜂鸣器“嘀”响一声，臀洗、妇洗、暖风功能才可以使使用。如果在喷洗过程中，人若站起，喷嘴还会维持喷水1~2秒，请先按停止键后再站起。

REMOTE CONTROL INSTALLATION

安装遥控器

Remote control installation

1. Place the remote control hanger upright on the pre-installed area of the wall and mark the location of the two mounting holes on the wall with a marker. Drill a hole in the marked position on the wall with a drill bit of 6 mm in diameter, with a depth of 35mm. (When determining the installation location, make sure that the user can reach remote control when he sits on the seat.)
2. Put the expansion tube into the wall hole and the hanger is tight against the wall. Align the hole in the hanger with the expansion tube and tighten the screw, and then cover the silicone gasket.
3. Put batteries into remote control and cover remote control.
4. Put remote control to the hanger.

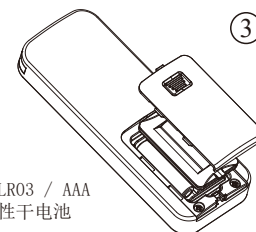
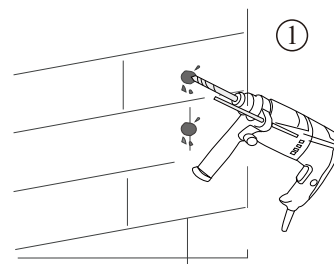

电池型号: LR03 / AAA
型 / 7 号碱性干电池

⚠ Battery installation and use precautions:

- ①. The original dry cell batteries are non-rechargeable. Do not recharge them.
- ②. Insert the batteries according to the "+" and "-" markings in the battery compartment. Do not insert them in reverse.
- ③. Remove exhausted batteries and dispose of them safely. Do not discard them carelessly.
- ④. Do not heat or disassemble the battery, or dispose of it in water or fire.
- ⑤. Do not connect the "+" and "-" terminals with metal wire, etc., and do not place it together with metal necklaces, hairpins, etc.
- ⑥. Do not mix old and new batteries, or batteries of different models or brands.
- ⑦. Do not use batteries with peeling casings, and do not use rechargeable batteries instead of dry cells.
- ⑧. When not in use for an extended period, remove the batteries from the product and store them securely, keeping them out of the reach of infants and young children.

Notice: 1. When determining the installation position, it is necessary to ensure that the remote control can be reached by hand when the person is sitting on the ring.
2. It is forbidden to install and use the product in the bathroom and other wet places. And do not put it in the place where it is easy to be drenched by water.

安装遥控器挂架

1. 将遥控器挂架竖直贴在墙上的预安装区域，用记号笔在墙上标识出两个安装孔的位置。用直径6mm的钻头在墙上已标识的位置钻孔，深度35mm。（确定安装位置时，需注意当人坐在座圈上，保证手可以抓到遥控器）
2. 将膨胀管装入墙孔内，挂架贴紧墙壁，挂架上孔对准膨胀管，放入螺钉锁紧，再盖上硅胶垫。
3. 将电池装入遥控器，盖上电池密封盖、电池盖。
4. 将遥控器放入挂架中。

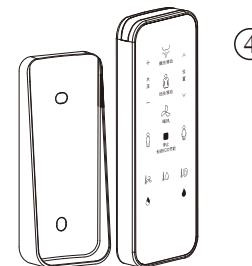
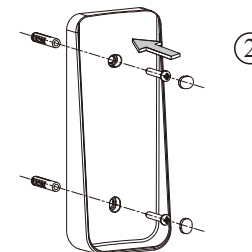

⚠ 电池安装使用注意事项:

- ①. 原配干电池为不可充电电池，请勿对干电池进行充电。
- ②. 请按照电池仓内的“+”和“-”标志装入电池，请勿装反。
- ③. 电池用尽应取出，并进行安全处置，请勿随意丢弃。
- ④. 请勿对电池进行加热、拆分，请勿放入水里或火里。
- ⑤. 请勿用金属丝等连接“+”和“-”极，请勿与金属制的项链、发夹等放置在一起。
- ⑥. 新旧电池不可混用，不同型号、不同品牌电池不可混用。
- ⑦. 请勿使用外壳已剥落的电池，请勿以充电电池代替干电池使用。
- ⑧. 长期不使用，请将产品内的电池取出并妥善保管，请勿置于婴幼儿能碰到的地方。

提示: 1、确定安装位置时，需注意当人坐在座圈上，保证手可以拿到遥控器。
2、请勿在浴室等潮湿的地方安装使用产品，禁止置于易被水淋到的地方。

Remote control installation

1. Clean and dry the pre-installed area of the remote control rack on the wall. (When determining the installation location, make sure that the user can reach remote control when he sits on the seat.)
2. Remove the adhesive tape on the back of the hanger and place it tightly against the wall, then cover the silicon gasket.
3. Put batteries into remote control and cover remote control.
4. Put remote control to the hanger.

安装遥控器挂架

1. 清洁并擦干墙上遥控器挂架预安装的区域。(确定安装位置时, 需注意当人坐在座圈上, 保证手可以抓到遥控器)
2. 将挂架背面双面胶贴纸撕下, 竖直贴紧墙壁, 再盖上硅胶垫。
3. 将电池装入遥控器, 盖上电池密封盖、电池盖。
4. 将遥控器放入挂架中。

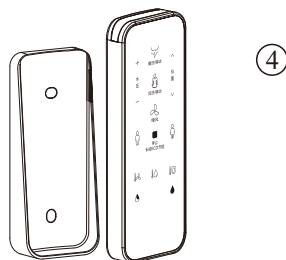
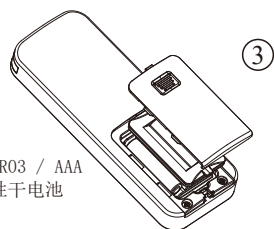
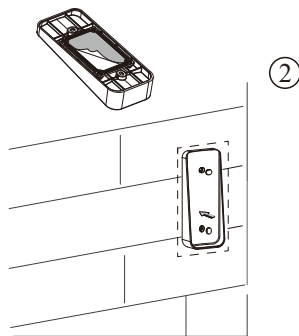
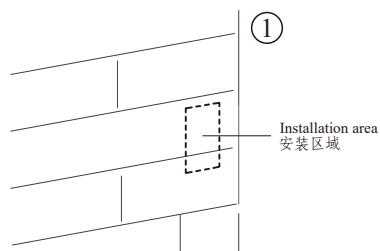

电池型号: LR03 / AAA
型 / 7 号碱性干电池

⚠ Battery installation and use precautions:

- ①. The original dry cell batteries are non-rechargeable. Do not recharge them.
- ②. Insert the batteries according to the "+" and "-" markings in the battery compartment. Do not insert them in reverse.
- ③. Remove exhausted batteries and dispose of them safely. Do not discard them carelessly.
- ④. Do not heat or disassemble the battery, or dispose of it in water or fire.
- ⑤. Do not connect the "+" and "-" terminals with metal wire, etc., and do not place it together with metal necklaces, hairpins, etc.
- ⑥. Do not mix old and new batteries, or batteries of different models or brands.
- ⑦. Do not use batteries with peeling casings, and do not use rechargeable batteries instead of dry cells.
- ⑧. When not in use for an extended period, remove the batteries from the product and store them securely, keeping them out of the reach of infants and young children.

Notice: 1. When determining the installation position, it is necessary to ensure that the remote control can be reached by hand when the person is sitting on the ring.
2. It is forbidden to install and use the product in the bathroom and other wet places. And do not put it in the place where it is easy to be drenched by water.

⚠ 电池安装使用注意事项:

- ①. 原配干电池为不可充电电池, 请勿对干电池进行充电。
- ②. 请按照电池仓内的“+”和“-”标志装入电池, 请勿装反。
- ③. 电池用尽应取出, 并进行安全处置, 请勿随意丢弃。
- ④. 请勿对电池进行加热、拆分, 请勿放入水里或火里。
- ⑤. 请勿用金属丝等连接“+”和“-”极, 请勿与金属制的项链、发夹等放置在一起。
- ⑥. 新旧电池不可混用, 不同型号、不同品牌电池不可混用。
- ⑦. 请勿使用外壳已剥落的电池, 请勿以充电电池代替干电池使用。
- ⑧. 长期不使用, 请将产品内的电池取出并妥善保管, 请勿置于婴幼儿能碰到的地方。

提示: 1、确定安装位置时, 需注意当人坐在座圈上, 保证手可以拿到遥控器。
2、请勿在浴室等潮湿的地方安装使用产品, 禁止置于易被水淋到的地方。

Main unit care and maintenance

1. Shut off power supply at maintenance.
2. Turn the seat upward open, press down the button located on the right side of main unit and pull out the seat. Wipe the stain with a soft damp cloth.
3. Safety self- inspection
After cleaning, re-connect the toilet with the power supply.

产品的保养

1. 切断电源
产品保养时请先切断电源。
2. 柔软抹布擦拭
请用拧干水分的柔软抹布擦拭脏污部位。
3. 安全自检
擦拭完成后请重新接上电源。

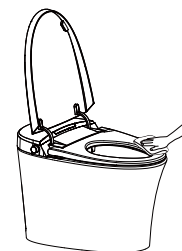

Spray nozzle maintenance and care 1.

1. Nozzle self-cleaning
Before or after rear and feminine cleaning, the nozzle starts self-cleaning and stops automatically after a period of self-cleaning.
2. Nozzle manual cleaning
 - The nozzle out
User not seated, the knob rotates clockwise to start the nozzle manual cleaning function, and the nozzle will automatically extend and flow out the washing water.
 - Spray nozzle disassemble
When the wand moves forward, the nozzle can be disassembled to clean.
 - Use soft cloth or soft brush to clean
Do not pull or push the wand, to avoid damage.
 - Nozzle assembly
Put the nozzle back to the front of the boom and press the "Stop" button to automatically retract the nozzle.

喷嘴的保养

- 1、喷嘴自洁
每次臀洗、妇洗开启前或臀洗、妇洗结束后, 喷嘴自动流水自洁一段时间后自动停止。
- 2、喷嘴手动清洗
 - 喷嘴伸出
人体无着座, 旋钮顺时针旋转启动喷嘴手动清洗功能, 喷嘴会自动伸出并流出洗净水。
 - 喷嘴拆卸
喷嘴自动伸出以后, 可拆下喷嘴头部清洗。
 - 请用柔软抹布或软毛刷擦拭
请勿将喷杆外拉或内推, 以免破坏喷杆或电机。
 - 收回喷嘴
将喷嘴头部装回喷杆前端, 短按旋钮启动停止功能, 喷嘴自动收回。

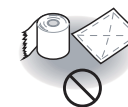
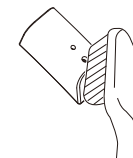
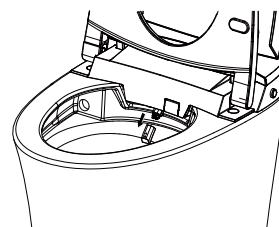

Electricity and water supply cut-off

1. Power failure
Press and hold the knob for flushing.
2. Water failure
Put around 8L water into a barrel and flush the bowl of ceramic.
Note: Avoid water spilling from bowl.

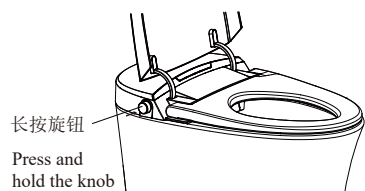
**停电停水**

1. 停电时冲洗坐便器的方法
长按旋钮，进行冲刷。
2. 停水时冲洗坐便器的方法
将水放入较大的水桶（约8L）内，以坐便器槽面为中心进行冲洗。此时，注意防止水从坐便器溢出。

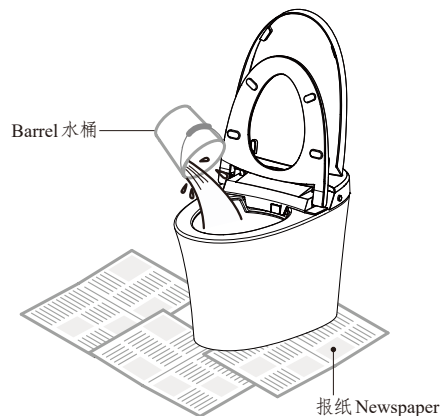
**Failure of remote control**

1. Operate the panels on ebidet seat to perform.
2. Battery replacement
Press the "power" button on panel and electricity indicator will turn off.
Take remote control from hanger.
Open battery cover to replace battery for recycling at special agency and put back to hanger. Press switch button again (indicator light will flash).

Remarks: When replacing the battery, the gear set by the remote control will return to the default value and need to be reset.

无法用遥控器进行操作时

1. 通过坐便器旋钮进行操作
2. 干电池的更换方法
 - 从遥控器挂架上取下遥控器
 - 打开电池盖，更换干电池并交给专业人员回收处理
 - 将换好电池的遥控器放回挂架上

温馨提示：更换电池时，遥控器设定的档位将恢复至默认值，需重新设定。

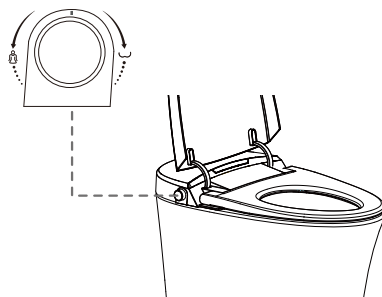
**Replacement of battery**

- Remove the smart cover from the toilet.
- Unscrew battery cover and remove the 9v dry battery for recycling at special agency.
- Put the smart cover with replaced battery on the toilet.

Notice: 1. When performing this step, it is recommended to have a professional perform the operation!
2. 9V dry battery, it is recommended to use high-quality 6LR61 dry battery.
3. It is recommended to flush the battery and replace it every two years, otherwise there may be a risk of leakage.
4. Please refer to page 19 for detailed instructions on battery installation and use.

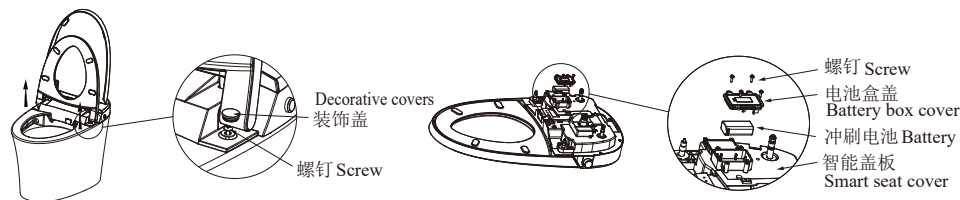
**When the product is left unused for long time**

- Especially in winter when no one at home for a long time, please drain out the water inside ceramic and pipe to prevent freezing.

To discharge water

1. Cut off the electricity
2. Drain out the water inside ceramic
Activate flushing, and then turn ovalve to prevent water inlet.
3. Drain out the water inside pipe
Unscrew the hose connector off angle valve, drain the water in the pipe and reinstall.
4. Handle the remaining water in bowl
It is suggested to put some antifreeze into water inside the bowl.

Tips: When you use this device again please do reconnect to water and power supply.

⚠ Note: Before water discharging, the power must be cut off !

3. 冲刷电池的更换方法

- 将智能盖板从坐便器上拆下
- 松开电池盒盖固定螺丝，取下9V干电池并交给专业机构回收处理
- 将换好电池的智能盖板装到坐便器上

提示:

1. 进行此步骤时，建议请专业人员进行操作！
2. 9V干电池，建议使用6LR61型号优质干电池。
3. 建议冲刷电池每两年更换一次，否则可能有漏液风险。
4. 电池安装使用注意事项详见第19页。

长时间不使用时

- 尤其是冬季，长期不在家时，请务必将陶瓷及管路中的水放掉，防止冻结。

放水的方法

1. 拔出电源插头，切断电源
2. 将坐便器陶瓷中的水排空
启动一次坐便器冲水，冲水完成后立即关闭进水角阀。
3. 将管路中的水排空
将软管从角阀上旋开，排空管路的水后重新装回。
4. 处理便器内积水
为了安全起见，建议将防冻液放入便器内的积水中。

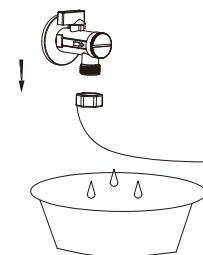

温馨提示：再次使用坐便器时，请务必再次通水、通电。

⚠ 注意：在电子坐便器放水前，必须切断电源！

PRECAUTIONS

1. Before using, please check whether the grounding of the power outlet connected to the toilet's plug is reliable.
2. The product uses 220V~, 50Hz power.
3. Prohibit stepping on the product or striking it with heavy objects.
4. Place the product far away from fire, and do not inject water to the product or wipe the surface of plastic components with gasoline and chemical solvents.
5. Children should use the product under supervision of an adult, refraining from using the product alone.
6. Do not unplug the power cord with wet hands or pull the power cord forcibly.
7. When out of service for a long time, please unplug the power cord from the socket. Meanwhile, drain remaining water in the product to prevent freezing in winter.
8. When there is a fault, please stop using the product immediately, and unplug the power cord, letting maintenance staff or specialists repair it.
9. During power outage, unplug the power cord, and close the angle valve to prevent leakage.

注意事项

1. 使用前应检查与大便座插头连接的电源插座应可靠接地。
2. 产品使用额定电压为220V~, 频率50Hz的交流电源。
3. 产品严禁人员踩踏或重物撞击。
4. 产品远离火源, 严禁向产品注水及汽油和化学溶剂擦洗塑料件表面。
5. 儿童应在成人监护下使用, 避免让儿童单独接触产品。
6. 请勿用湿手插拔电源插头或用力拉扯电源线。
7. 长期不用时, 应将电源插头从插座上拔下。同时将产品内部积水排净, 以防冬天结冰。
8. 产品出现故障应立即停止使用, 取下电源插头, 由维修部或专业人员修理。
9. 当突然停电时, 请拔掉电源插头, 关闭角阀, 防止漏水。

TROUBLESHOOTING GUIDE

故障分析和处理

Problem	Cause	Solution
No flushing	Water supply hose buckling causes block	Solve the buckling
	Angle valve is off	Turn on the angle valve
	Water supply is cut off	Connect water supply and wait for the water
Poor flushing	Water supply hose buckling causes partial block	Solve the buckling
	Angle valve is not fully turned on	Turn on the angle valve fully
	Filter is dirty and causes block	Clean the filter
The water is not hot	The water temperature is setted on normal temperature level	Reset the water temperature
Seat temperature is not hot	The seat temperature is setted on normal temperature level	Reset the seat temperature
	In standby mode or power save mode	Shift to function mode for 3 minutes
Wind temperature is not hot	The wind temperature is setted on normal temperature level	Reset the wind temperature
No wind out	In standby mode	Shift to function mode to use dry function
spray wand cannot retracted	Power off	Push back the wand lightly and wait for the power
	Get stuck by impurities	Clear away the impurities
Spray wand cannot stretch out	Power off	Push back the wand lightly and wait for the power
	Do not sit in sensing area	Sit right in the sensing area
Controller cannot display	Controller control battery low	Replace the Controller battery
	Reverse the polarity of battery	Reload the battery
Malfunction of deodorization	User doesn't reach the sensing area in seat	Adjust to reach the sensing area
	Deodorization functio keeps working after user leaves	It's a normal phenomenon if deodorization function keeps working after user leaves to ensure eliminating smell entirely
When power is off, there will be no flush by pressing knob	battery out of power	Take E bidet off of the toilet, open the battery box lid from the bottom of E bidet and replace the battery

TROUBLESHOOTING GUIDE

故障分析和处理

现象	原因	处理
不喷水	进水管弯折造成堵塞	排除进水管弯折
	角阀关闭	打开角阀
	自来水断水	等待来水
喷水强度弱	进水管弯折造成部分堵塞	排除进水管弯折
	角阀未完全打开	完全打开角阀
	进水滤网阻塞	清洗进水滤网
水温不热	水温设定常温档	重新设定水温档位
座温不热	座温设定常温档	重新设定座温档位
	处于待机或省电模式	切换到功能模式3分钟后使用
风温不热	风温设定常温档	重新设定风温档位
不出风	处于待机模式	切换到功能模式使用暖风功能
喷杆不缩回	断电	将喷杆轻轻推回, 等待来电
	被异物卡住	清除异物
喷杆不伸出	断电	等待来电
	未坐到着座感应区	位置坐正, 坐到感应区
	遥控器电池电量不足	更换遥控器电池
遥控器失效	遥控器电池正负极装反	重新装电池, 对准正负极
	使用者没有接触座圈上的感应器	调整至接触到座圈上的感应器
除臭功能不正常工作	离开座圈后, 除臭功能继续工作	使用者离开座圈后, 除臭功能会继续工作一段时间, 确保完全消除异味, 这是正常现象
停电后, 按压本机旋钮不冲水	冲刷电池电量不足	拆下智能盖板, 从智能盖板底部拆开电池盒盖, 进行更换冲刷电池

△ 注意: 如果按上述方法处理后故障仍未排除, 应切断电源, 联系服务商, 请专业人员维修。
如果电源漏电保护开关时常跳开, 表示产品有漏电, 请切断电源, 联系服务商, 请专业人员维修。

CONTACT INFORMATION

联系信息

Shanghai Chehe Trading Co., Ltd.
Address: Floor 2, No.126,128,130 Jiang Chang San Road, Jing An District, Shanghai, PRC.
Tel: 400-920-8262
Postcode: 200436

上海澈和贸易有限公司
地址: 上海市静安区江场三路126、128、130号2层
电话: 400-920-8262
邮编: 200436

产品中有害物质含量的说明

回收提示

本产品超过使用期限或经过维修无法正常使用后，不应随意丢弃，请交由有废弃电器电子产品处理资质的企业处理，正确的处理方法请查阅国家或当地有关废旧电器电子产品处理的规定。

有害物质统计表

产品中有害物质的名称及含有的信息表										
部件名称	有害物质									
	铅 (Pb)	汞 (Hg)	镉 (Cd)	六价铬 (Cr(VI))	多溴联苯 (PBBs)	多溴二苯醚 (PBDEs)	邻苯二甲酸二正丁酯 (DBP)	邻苯二甲酸二异丁酯 (DIBP)	邻苯二甲酸丁苄酯 (BBP)	邻苯二甲酸(2-乙基)己酯(DEHP)
塑料组件	○	○	○	○	○	○	○	○	○	○
控制类组件	×	○	○	○	○	○	○	○	○	○
PCBA 组件	×	○	○	○	○	○	○	○	○	○
电机类组件	×	○	○	○	○	○	○	○	○	○
导线类组件	○	○	○	○	○	○	○	○	○	○
进水组件	○	○	○	○	○	○	○	○	○	○
* 喷管组件	○	○	○	○	○	○	○	○	○	○
加热组件	×	○	○	○	○	○	○	○	○	○
* 遥控器组件	×	○	○	○	○	○	○	○	○	○
* 电池	○	○	○	○	○	○	○	○	○	○
* 陶瓷类组件	○	○	○	○	○	○	○	○	○	○
* 水箱组件	○	○	○	○	○	○	○	○	○	○

注1：○：表示该有害物质在该部件所有均质材料中的含量均不超出电器电子产品有害物质限制使用国家标准要求。

×：表示该有害物质至少在该部件的某一均质材料中的含量超出电器电子产品有害物质限制使用国家标准要求。

注2：以上未列出的部件，表明其有害物质含量均不超出电器电子产品有害物质限制使用国家标准要求。

*：表示部分机型含有该部件。

注：本表格提供的信息是基于供应商提供的数据及瀚和公司的检测结果。本产品应用环保设计理念，在当前技术水平下，所有有害物质或元素的使用已经控制到了最低程度，瀚和公司会继续努力通过改善现有技术来减少这些物质的使用。



本产品的“环保使用期限”为10年，瀚和公司根据产品设计特性指定该期限。只有在本产品使用说明书所述的正常情况下使用本产品时，“环保使用期限”才有效。

智能坐便器施加的水效能效标识的说明：该水效能效标识是表示智能坐便器水效能效等级等性能的一种符合性标志。

修改说明

Modification description

版本	修改日期	修改原因	
1534345-T2-B	2025-04-17	删除水效说明表格	
1534345-T2-C	2025-11-19	RoHS升版	
1534345-T2-D	2026-01-04	更改新国标相关内容	
1534345-T2-E	2026-04-09	更改用水量	

